

iQntrol

# DOS-COMPLETE

EN

CLF, Redox

SMART POOL MANAGEMENT SYSTEM



INTEGRATED  
VS PUMP  
CONTROL



# Table of Contents

General safety information	4
What is in the box	6
Available optional accessories	7
Recommended Chemistry (Aseko)	7
DOS-COMPLETE	8
Pool technology management	9
DOS-COMPLETE Installation	10
Installing the Probes	11
Pool Water Connection	13
Pool Chemicals Connection	15
Accessories Connection	16
VS pump connection	17
Integration of Ocean® pump Inver iQ 300	18
Power Supply	20
Installation Test	21
Touch screen description	22
Configuration	24
Integration automatic Aquastar® backwash valve	29
Choosing the type of probe or the type of time dosing	30
Commissioning procedure and required value setting	30
If you use the CLF probe	32
If you use the Redox probe	33
Safety functions	34
Operation	34
In operation measurement and calibration	35
Maintenance	38
Winterizing - storage during winter	40
Internet connection	42
Web services	44
Externes touchscreen display	48
SPARE PARTS & ACCESSORIES	49



# General safety information

This user manual contains basic information that should be observed during assembly, start-up, operation, and maintenance. Therefore, this user manual must be read by installers and operators prior to assembly and start-up, and must be accessible to every user of this unit. Additionally, all further safety information in this document must be observed. Read and follow all instructions. In order to minimize the danger of injury, do not allow children to use this product. Non-compliance with safety information can result in hazards to persons, the environment and the equipment. Non-compliance with safety information will result in a forfeit of any potential right to damage compensation.

## Insufficient personnel qualification

Hazards in the event of insufficiently qualified personnel, potential consequence: Injury, heavy material damage.

- The system operator must ensure compliance with the required qualification level.
- Any and all work may only be performed by correspondingly qualified personnel.
- Access to the system must be prevented for insufficiently qualified persons, e.g. via access codes and passwords.

## Potential overdosing of chemical agents

Despite DOS-COMplete® comprehensive safety functions, it is possible that a probe failure and other errors could lead to an overdosing of chemical agents. Potential consequence: Injury, heavy material damage.

- Design your installation such that uncontrolled dosage is not possible in the event of a probe failure or other errors, and/or such that uncontrolled dosage is recognized and halted before damage is incurred.
- Uncontrolled overdose of chemicals can cause harm to health and property. Even though the device contains a number of security elements can not be ruled out that in case of failure of the measuring probes, or the whole device may result in overdose of chemical agents. Install the equipment so that uncontrolled overdose of chemicals was not possible and that uncontrolled overdose has been detected in time before causing any harm. It is necessary to use chemicals in such quantities that an overdose will not cause dangerous concentration of chemical agents. Do not use chemicals in too large packages or with too high concentration.

## Gaseous chlorine produced from dosing in standing water if dosing outputs are not closed via the filter pump

If the flow switch is stuck or experiences another error, there is a risk of dosing into standing water. Poisonous chlorine gas can be yielded when sodium hypochlorite and pH minus come together.

## Non compliance with informational text

Not observing informational text may lead to hazards. Potential consequence: gravest degree of injury, heavy material damage.

- Read all informational text carefully.
- Cancel the process if you are unable to exclude all potential hazards.

## Use of new functions

Because of the continued development, a DOS-COMPLETE® unit may contain functions, which are not completely described in this version of the user manual. The use of such new or extended functions without a profound and secure understanding by the operator may result in malfunctions and severe problems. Potential consequence: Injury, heavy material damage.

- Make sure to get a profound and secure understanding of a function and relevant boundary conditions, before you start to use it.
- Check for an updated version of the user manual or additional documentation available for the relevant functions.
- Make use of the integrated help function of the DOS-COMPLETE® to get detailed information on functions and their parameter settings.
- In case it is not possible to get a profound and secure understanding of a function based on the available documentation, do not use this function.

## Overdosing if pH value is wrong

If disinfection is enabled before the pH value is stable in the ideal range of 7.0 to 7.4, then it may lead to heavy overdosing of chlorine or bromine. Potential consequence: Injury, heavy material damage.

- Do not start disinfection with chlorine until the pH value is stable in the ideal range between 7.0 and 7.4.

## Conditions before using

Make sure you have a newest and updated version of the user manual and other documentation for all functions of the unit. Use and read the integrated help features. In case of not understanding the information about certain features of the unit, do not use these features.

## Handling chemicals for pool water treatment

The chemicals used with the DOS-COMPLETE must be handled in a safe manner to prevent damage or personal harm. Peraqua recommends you always use personal protective safety equipment when handling the pH and chlorine agents. Refer to the Materials Safety Data Sheet (MSDS).

**WARNING:** Never mix the pH agent with the chlorine agent. When carrying out maintenance on the clear plastic tubes or valves always rinse with clean water to prevent mixing of the pH and chlorine agents.



# What is in the box



CLF probe  
(only for DOS-COMPLETE CLF)



or

Redox probe Long Life  
(only for DOS-COMPLETE Redox)



pH probe Long Life



Coagulation mixer  
(only for DOS-COMPLETE OXY)



Water valves 2 pcs



Injection valve 4 pcs



Suction tube weight 4 pcs



PVC reductions 1/2" ET to 1/4" IT 6 pcs



Dowels and screws



PE Tube 1/4" (6.35 mm) transparent 15m





# Available optional accessories

Inserting DN50 plug  
1/4" threaded



Pressure-type level sensor



External touch display



Lovibond® Scuba3s  
Multiparameter Pool Tester



pH 7.00 Buffer  
Redox Buffer



Air thermometer

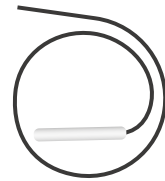

Aquastar® Easy 2  
incl. pressure sensor



# Recommended Chemistry (Aseko)

## 20 l or 5 l volume

CHLORPURE #12075  
(only for CLF and Redox)



OXY PURE #13038  
(only for OXY)



pH MINUS #12130



pH PLUS #12120



ALGICID #12156



FLOC+C #12139



## Volume 10 kg

BALANCER #13039



MAGNESIUM #13039



## Bottle 1 kg

SUPER CHLOR #13120



# DOS-COMPLETE

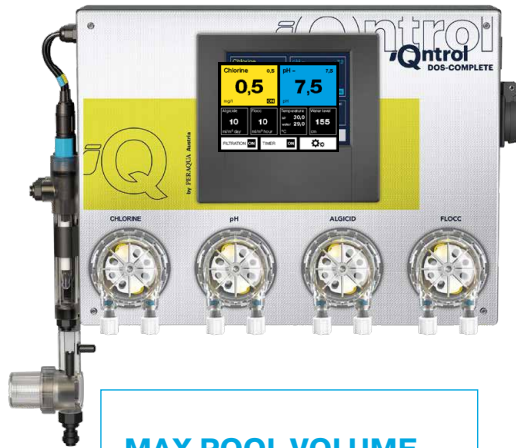

**MAX POOL VOLUME**  
250 m<sup>3</sup>

DOS-COMPLETE is an advanced system for pool water treatment and pool technology management. The pool water treatment with chlorine or chlorine-free disinfection, precise pH management, boosted by dosing of Algicide and Flocculating aid assure the crystal-clear water of your pool by use of the lowest necessary amount of chemical aids. The Pool Technology Management functions automate the operations of your pool and minimize the requirements for manual maintenance. The touchscreen display shows all information about water quality and allows easy setup of the entire system. With internet connectivity, you can monitor your pool parameters through a mobile or web application.

## Pool water treatment

**Balanced combination of treatment aids provide crystal clear pool water**

### Chlorine control and dosing

Highly effective disinfection to use with the chlorine technology DOS-COMPLETE CLF and DOS-COMPLETE Redox. Accurate measurement in combination with the dosing algorithm maintain the required values of disinfection while using the lowest necessary amount.

### OXY Pure

Active oxygen for chlorine-free technology DOS-COMPLETE OXY. Active oxygen in the combination with precise pH management, dosing of algicide and FLOC+C maintains clean and crystal-clear water without the use of chlorine.

### pH control and dosing

Accurate measuring by pH probe long-life in combination with the dosing algorithm assures the required water quality. Dosing of pH MINUS or pH PLUS.

### ALGICIDE dosing

The effective polymeric biocide protects water against algae, fungi, moulds and bacteria.

### FLOC+C dosing

FLOC+C contains flocculation and coagulation components. Its continual dosing improves filtration capability of removing even the smallest impurities. To increase the effectiveness of FLOC+C use coagulation mixer.





# Pool technology management

## Filtration Time Control

Daily, automatic start of the filtration system in individually preset periods.

## Water Level - Refilling

System can be programmed to control four different water levels at your pool and switch the water refilling or automatically use the excessive water for filter backwash. Requires optional **level sensor**.

## Filter Backwashing

The system can control backwash (this requires an optional automatic backwash valve, e.g. Aquastar® Easy 2).

## Smart Heating Control

The system is equipped by intelligent control of preset water temperature. It can switch and control the heating (**solar heating, electrical heating, gas heating, heat exchanger**) by logic of integrated smart heating functions.

## Winter mode

The Winter mode ensures the pool remains at a safe temperature during cold weather conditions.

## Variable speed pump control (VS pump)

In the settings, select the type of your variable speed pump. DOS-COMPLETE allows to use 4 speeds:

Speed 0 (OFF)

Speed 1 (LOW) for economical filtration outside the filtration TIMER.

Speed 2 (MEDIUM) during filtration TIMER.

Speed 3 (HIGH) during filter backwash.

## Switching BOTTOM / OVERFLOW

Allows automatic switching of water flow from the pool via the skimmer/overflow during filtering or via the floor drain outside of the set times, when the filter is backwashed and when the frost protection function is activated.

## Pool cover position (relay closed)

If the pool cover is closed during the set TIMER times, the speed of the VS pump will automatically change to 1 (LOW).

## Control by External touch display

DOS-COMPLETE can be monitored and controlled by external touch display (this function requires an optional **External touch display**).

## Programmable relay

DOS-COMPLETE has one integrated programmable relay to control an extra accessory.

## Solar heating control

The DOS-COMPLETE can monitor the temperature of the water in solar modules. When a set value is reached, the water is automatically directed through the solar modules. For this, an optional Praher ball valve with ER actuator and an outside temperature sensor are required.

Praher 2W ball valve M1



# DOS-COMPLETE Installation

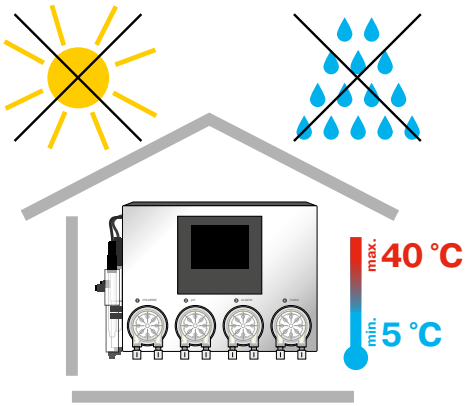

The DOS-COMPLETE must be operated in indoor environment with a temperature range of +5 to +40 °C, and the relative humidity must not exceed 70 %. Direct sunlight, high humidity, and dust may damage the DOS-COMPLETE.

- Before installing, ensure that pool water is chemically clean and without dirt.

Install the mounting rail and attach the DOS-COMPLETE to the wall. Choose a location with a free space of at least 40 cm in all directions, and a height above the floor must not be higher than 150 cm.

- The vertical distance between DOS-COMPLETE and the bottom of containers must not exceed 2 m.
- The maximum distance from injection valves to peristaltic pumps must not exceed 8 m.

**RECOMMENDATION:** Install the DOS-COMPLETE so that even in case of leakage of chemicals from the pumps or pipes, there is no damage to other equipment or spillage on the floor. Use drip trays.

Do not install any other devices under DOS-COMPLETE.

**WARNING:** High relative humidity reduces the lifespan of electronic components, particularly displays. If the DOS-COMPLETE is in an environment with high relative humidity and low temperature (such as the installation shaft, or garden house), keep the device permanently ON. The temperature in the device will be higher than the ambient temperature, resulting in a significant reduction of relative humidity within the device.

**This also applies when storing the unit during the winter.**

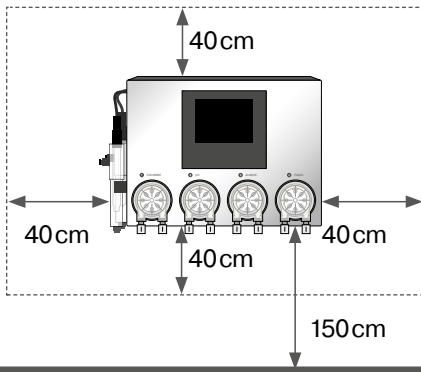

Wall bracket

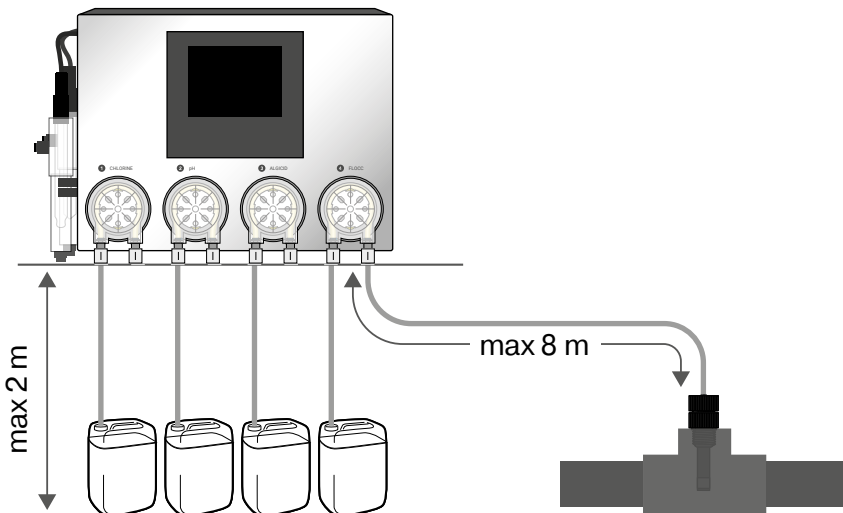
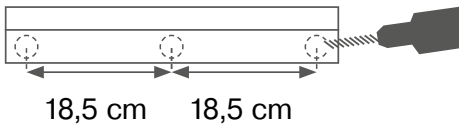

# Installing the Probes

1. Carefully insert the pH, CLF or REDOX probe into the housing.
2. Hand tighten or use the plastic wrench socket for probes.
3. To connect the probe tighten the connector on the probe connection cable.

After probes have been inserted, slightly tightened and connectors have been connected, DOS-COMPLETE is ready for connection to the water system of your pool.

**WARNING:** Only hand tighten the probes or use the plastic wrench socket for probes. Do not use pliers or steel wrench.

## Step 1: Installation of pH probe

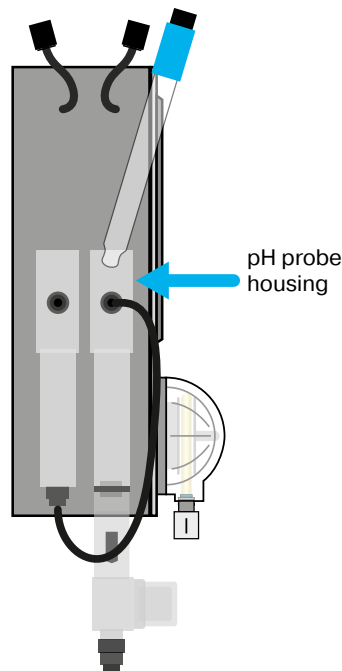

pH Long Life probe



## Step 2: Installation of CLF or Redox probe (only for DOS-COMPLETE CLF and Redox)

CLF probe

Redox probe Long Life

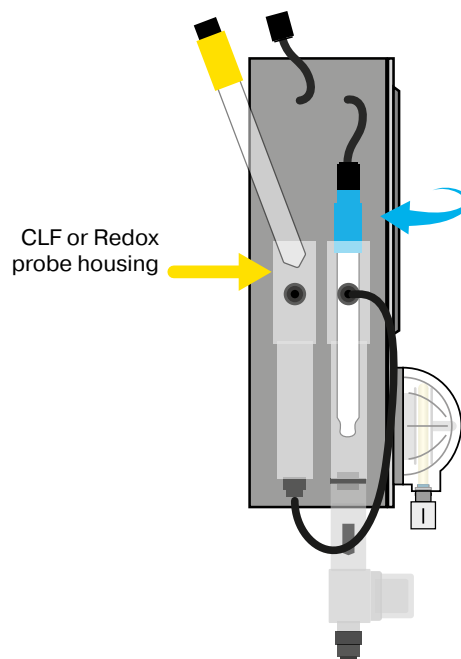

Wrench socket for probes



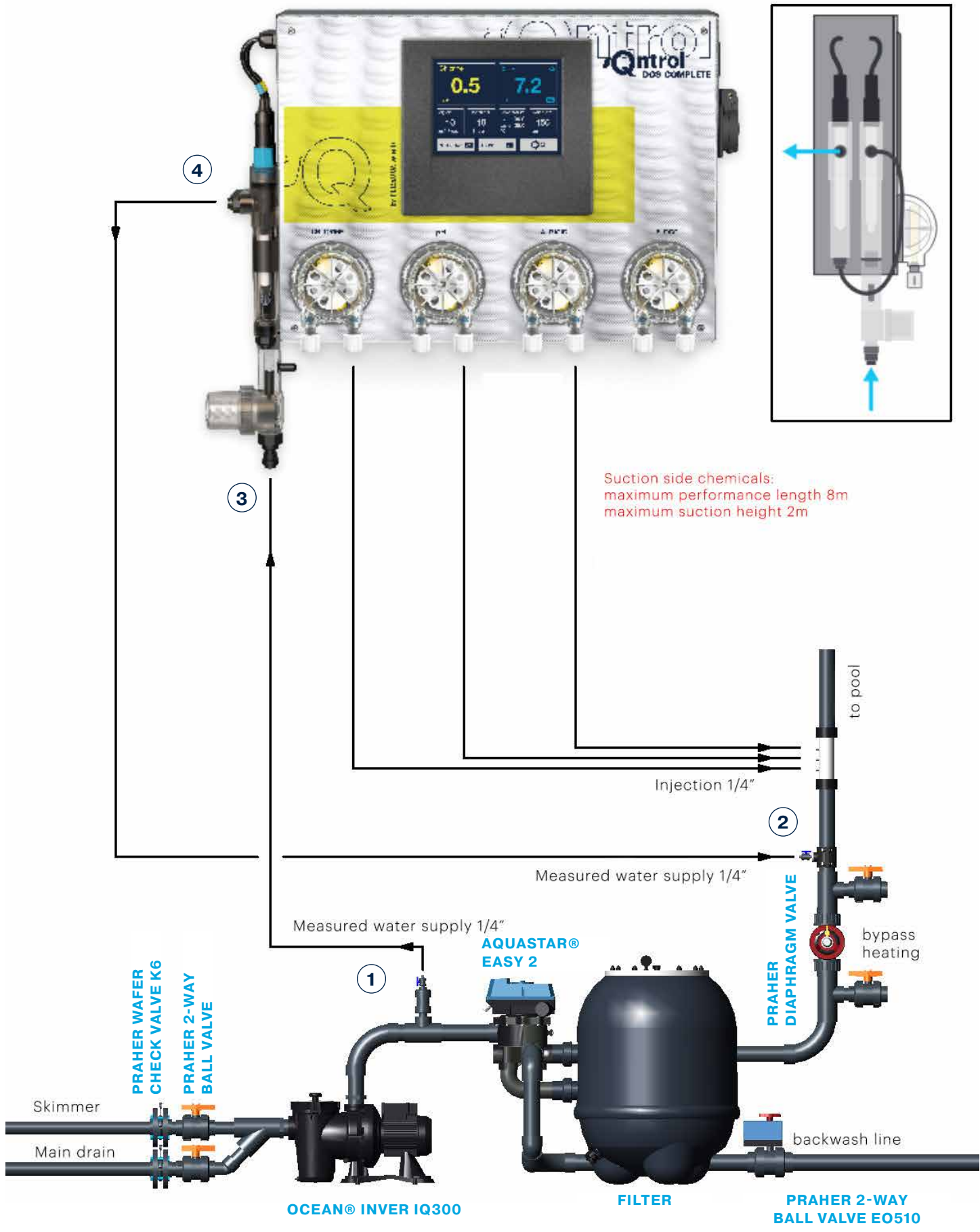

# Pool Water Connection

Screw the **measuring water valve** in the glue head D50 with thread G1/4", glued to the T-piece. **Tighten the measuring water valve into the head by hands only. Do not use pliers or other tools.**

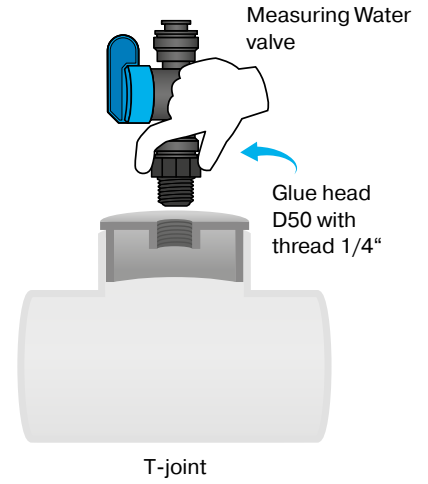

- 1 Connect the **MEASURED WATER SUPPLY** to the pipe **behind the pump, and before the filter and before the coagulation mixer.**
- 2 Connect the **MEASURED WATER DRAINAGE** to the pipe **behind the filter** and behind the heating or into the overflow tank or skimmer.

To connect the measured water to the DOS-COMPLETE use PE tube 1/4" (6.35 mm), which is part of the packaging.

## WARNING

Cut the PE tube at an angle of 90° to ensure tight joints. The cut must be clean. **Use special pliers to cut plastic tubes. Do not use common scissors or knives!**

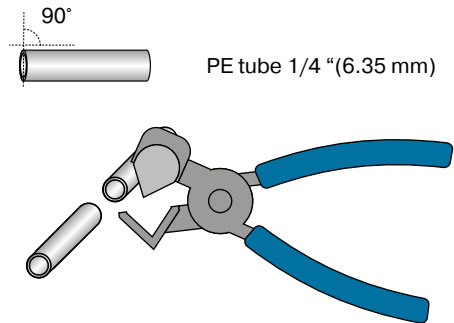

The measured water is easily connected to DOS-COMPLETE using the **Speedfit** push-in fitting.

**CONNECTION** Push the connecting pipe into the Speedfit fitting and pull out the hose to secure.

**DISCONNECT** push and hold the Speedfit round collet and pull out the connecting pipe.

- 3 **INLET** of the measured water to the DOS-COMPLETE  
Connect the tube to the bottom Speedfit of the measured water filter.
- 4 **OUTPUT** of the measured water from DOS-COMPLETE  
Connect the tube to the side Speedfit on the probe housing.

Once connected, DOS-COMPLETE is ready to measure disinfectant content and pH value in your pool.

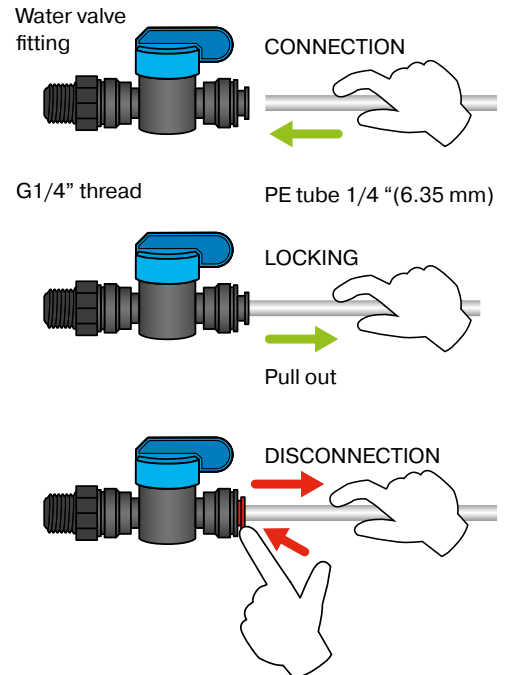

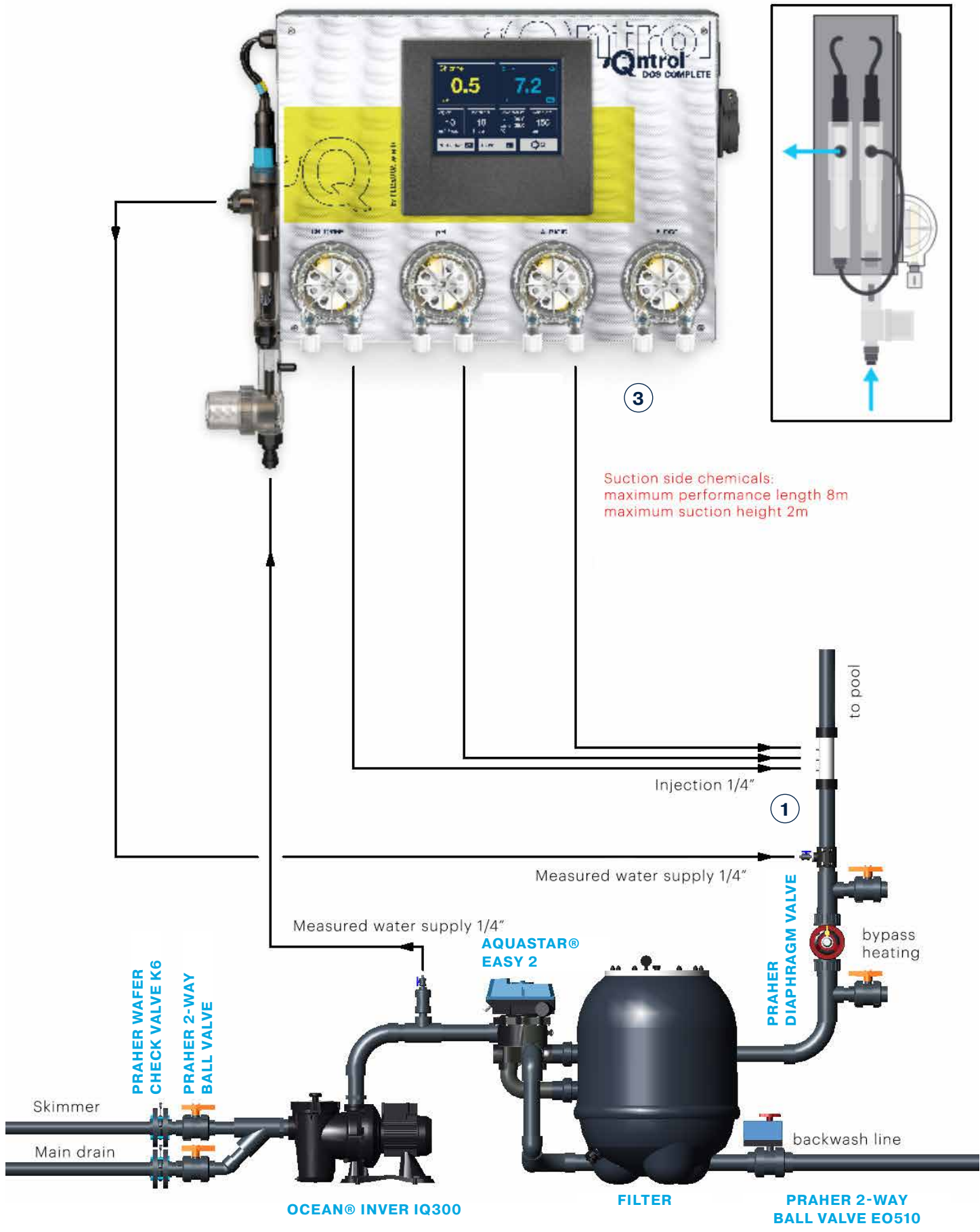

3

Suction side chemicals:  
 maximum performance length 8m  
 maximum suction height 2m

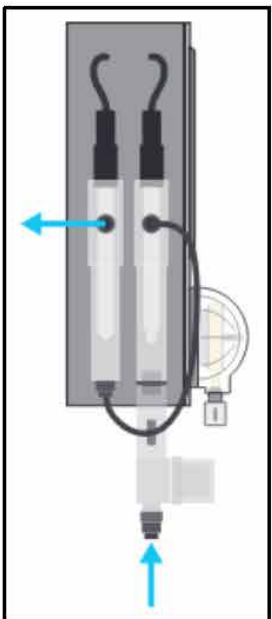

1

PRAHER WAFER  
 CHECK VALVE K6  
 PRAHER 2-WAY  
 BALL VALVE

PRAHER  
 DIAPHRAGM VALVE

PRAHER 2-WAY  
 BALL VALVE EO510



# Pool Chemicals Connection

Screw the **injection valve** in the glue head D50 with thread G1 / 4 “, glued to the T-piece. **Tighten the injection valve into the head by hands only. Do not use pliers or other tools.**

Connect the **FLOC+C INJECTION VALVE** to the pipe **before the coagulation mixer and before the filter and after the MEASURED WATER SUPPLY.**

- 1 Connect the **ALGICIDE, pH, and CHLORPURE or OXYPURE INJECTION VALVE** to the pipe **behind the filter and behind the MEASURED WATER DRAINAGE.** Connect injection valves in this order to prevent formation of lime scale.

To connect reagents from cans to the DOS-COMPLETE and from the DOS-COMPLETE to the injection valves use PE Tube 1/4 “(6.35 mm), which is part of the packaging.

## WARNING

Cut the PE tube at an angle of 90 ° to ensure tight joints. The cut must be clean. **Use special pliers to cut plastic tubes.** Do not use common scissors or knives!

- 2 **CANISTER CONNECTION** Drill 6.35 mm and 1 mm diameter holes in the can’s cap. Pass the tube through the hole in the cap so that it reaches the bottom of the can. Place the suction tube weight at the end of the tube.
- 3 **PUMP CONNECTION** Connect the can with the left (suction) connector of the pump using a PE tube from the can.
- 4 **INJECTION VALVE CONNECTION** Pass the tube through the injection valve nut, connect the tube onto the injection valve and tighten the nut firmly by hand. Connect the tube from injection valve with the right (discharge) connector of the pump.

## WARNING

**NEVER CONNECT pH minus reagent to disinfection pump or disinfectant to pH pump!** In the case of a cross-connection, after ten doses DOS-COMPLETE displays an error message. Repair the piping installation and then you can continue to operate your DOS-COMPLETE.

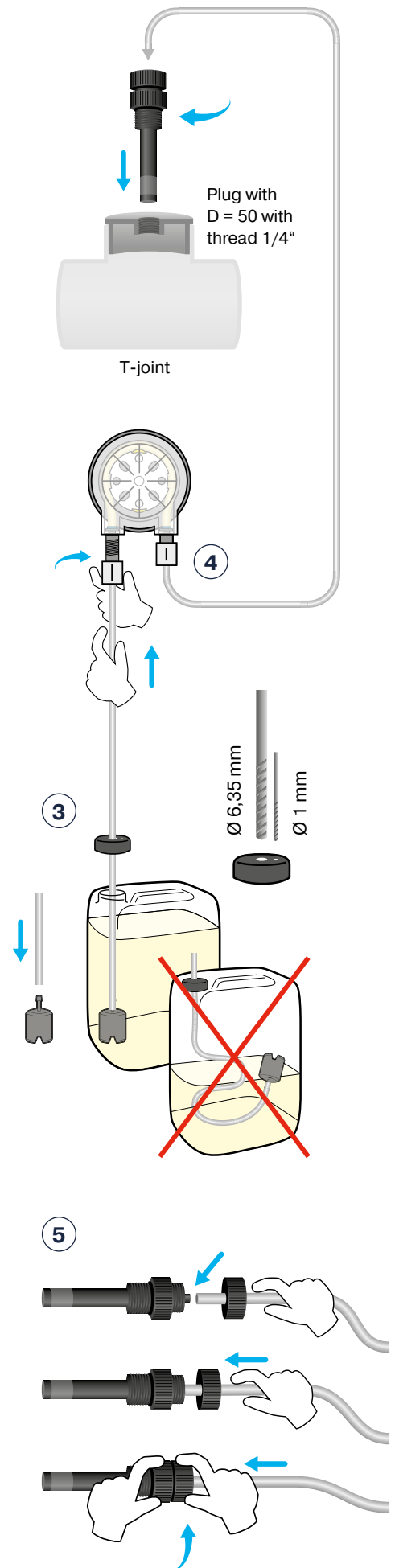

# Accessories Connection

## POWER SUPPLY

230 V ~ 50 Hz

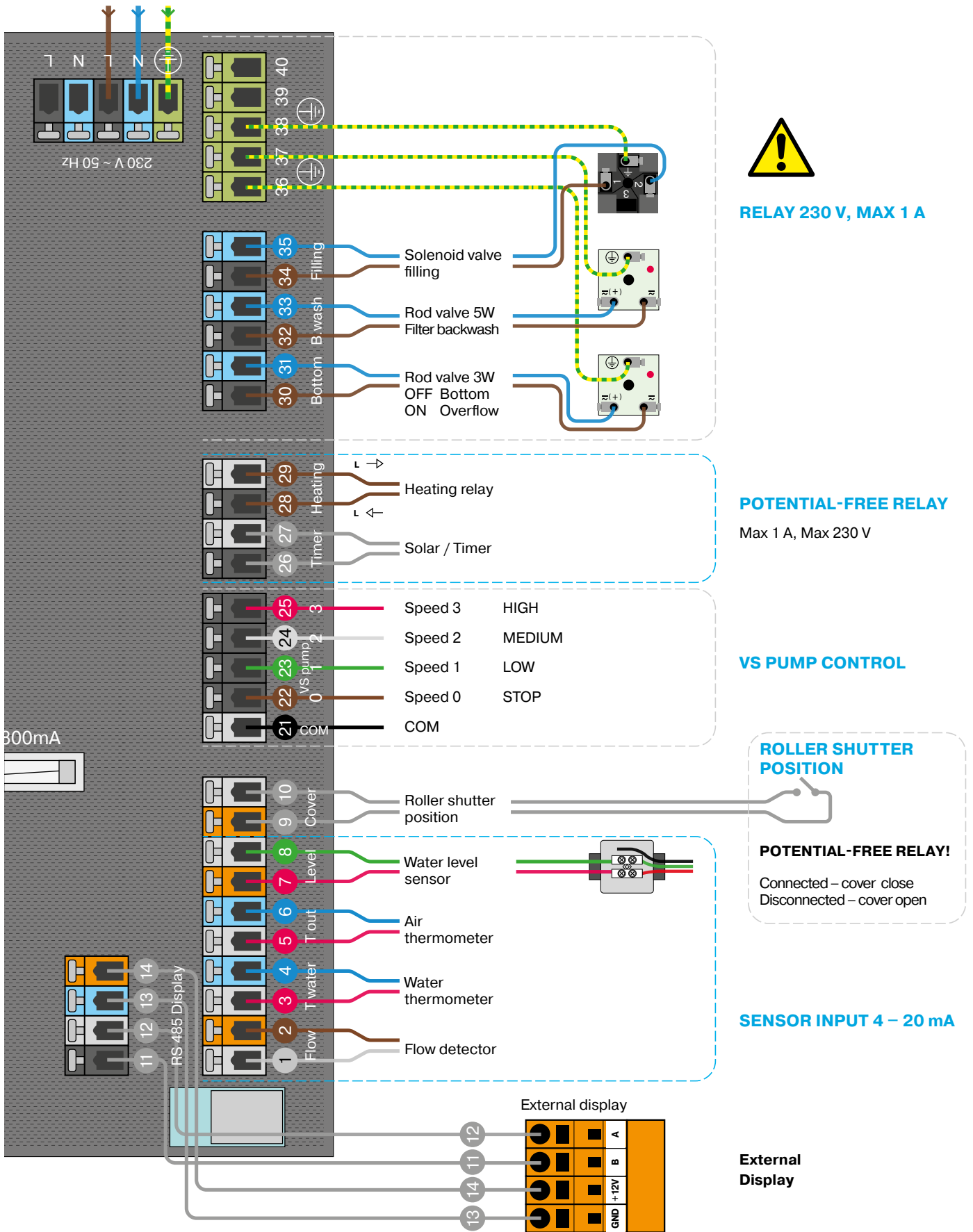

# VS pump connection

## WARNING

Always check the connection according to the current user manual of your pump manufacturer.

Speed

### TYP A

COM	S1	S2	S3	STOP
n1	ON	OFF	OFF	OFF
n2	OFF	ON	OFF	OFF
n3	OFF	OFF	ON	OFF
S	OFF	OFF	OFF	ON

### TYP B

COM	S1	S2	S3	S4
n1	ON	OFF	OFF	OFF
n2	OFF	ON	OFF	OFF
n3	OFF	OFF	ON	OFF
S	OFF	OFF	OFF	ON

### TYP C

COM	S1	S2	S3	STOP
n1	ON	OFF	OFF	OFF
n2	OFF	ON	OFF	OFF
n3	OFF	OFF	ON	OFF
S	ON	ON	ON	OFF

Relay status

## TYPE C

### Ocean® Inver iQ 300 / HAYWARD TYP C

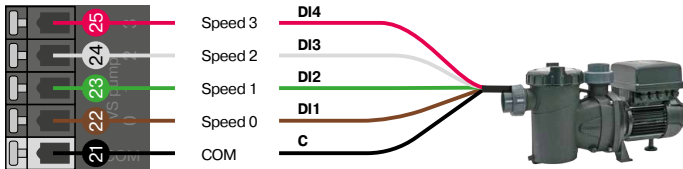

## TYPE A

### SPECK

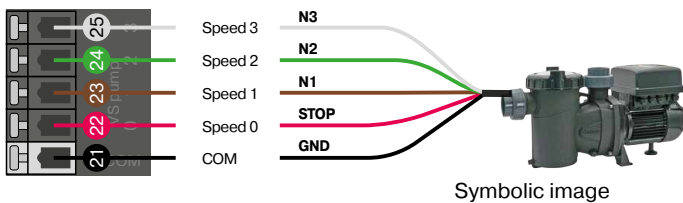

Symbolic image

### UWE EO PM

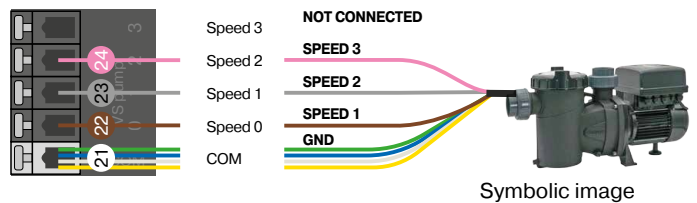

Symbolic image

### INVERTER POOL PUMP

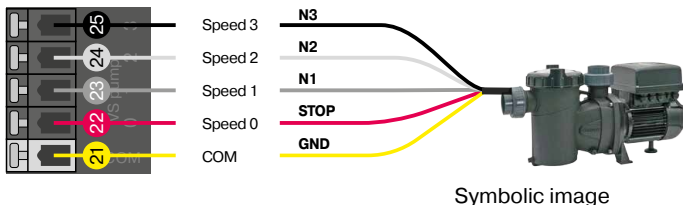

Symbolic image

### HAYWARD KS Evo VS

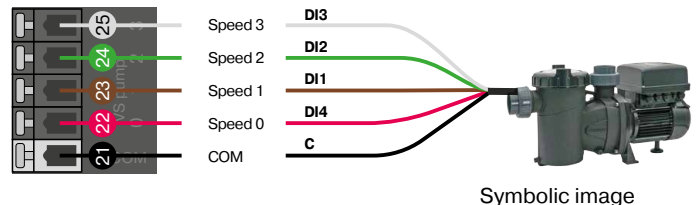

Symbolic image

## TYPE B

### PENTAIR

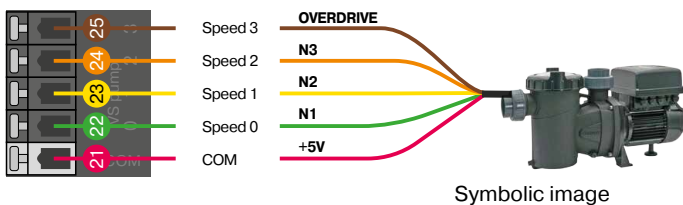

Symbolic image

### DAB E.SWIM - E.PRO

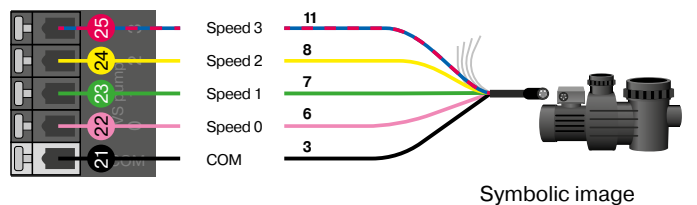

Symbolic image

# Integration of Ocean® pump Inver iQ 300



1. Connect the Ocean® Inver iQ300 electronically to the water treatment system according to the following illustration

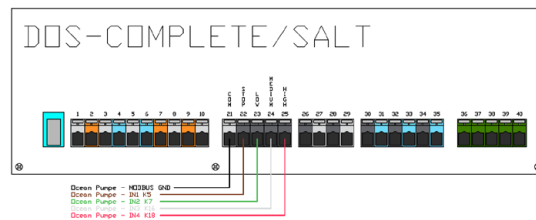
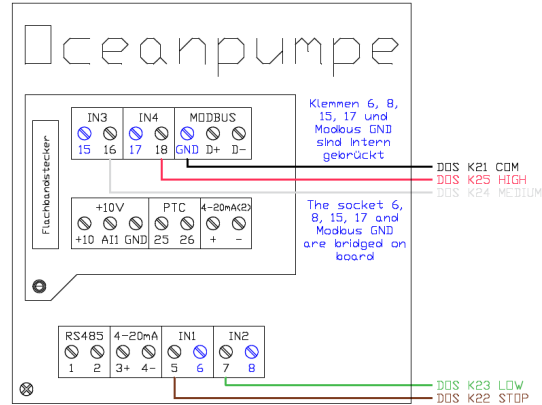

After the connection has been successfully established, the following settings must be made.

- Setting filter pump release or EMERGENCY STOP function



Change to EMERGENCY STOP



- Setting the various pump outputs / digital inputs



Rename IN2 to Speed 1



Set the desired volume flow (IN2 | Speed 1 = low volume flow, optional for circulation outside of filter times)



Duration must be set to 0min



Repeat the process again for IN3 + IN4

8.17 IN3 -> rename to SPEED 2

8.18 Set volume flow = normal volume flow in filtration mode

8.19 Set duration to 0min

8.21 IN4 -> rename to SPEED 3

8.22 Set volume flow = volume flow for backwashing

8.19 Set duration to 0min

## 2. Testing the settings

Finally, the settings in the “Output test” menu must be tested, i.e. it is checked whether the filter pump also carries out the “commands” of the dosing or salt system correctly.

You must check every setting, the test of the Speed 0 setting is very important, as the filter pump must be switched off while the Aquastar is moving.

The corresponding operating mode must then be displayed on the pump:

Speed 0 = EMERGENCY SHUTDOWN

Speed 1 = Speed 1

Speed 2 = Speed 2

Speed 3 = Speed 3





**Installation must be protected by a residual current device (RCD).**

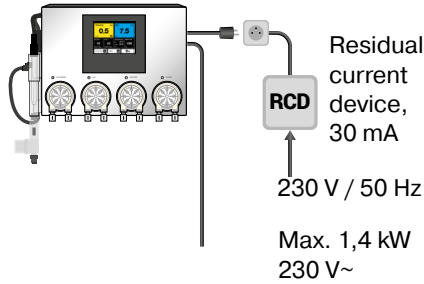

## Power Supply

### Connection to the mains:

1. Leave the mains switch in the OFF position.
2. Connect filtering device to the DOS-COMPLETE switched socket outlet (filtration power supply - max. 1.4 kW / 230 VAC).
3. Connect the 230 V / 50 Hz mains cable to DOS-COMPLETE (on the right side). The mains socket outlet must be protected by a residual current device (RCD).
4. Change the mains switch over to the ON position.

After Device has been switched on, the display will come on and the DOS-COMPLETE starting screen will appear.

### Disconnection from the mains:

1. Change the mains switch over to the OFF position.
2. Disconnect the DOS-COMPLETE mains cable from the 230 V / 50 Hz socket outlet.
3. Disconnect the filtering unit mains cable from DOS-COMPLETE.

**WARNING:** If device is used in the manner different from that specified by the manufacturer, protection provided by device may get damaged.

Power supply	230 V / 50 Hz
Power consumption	24 VA
Power consumption (including filter pump)	1449 VA
Maximum input power of connected filtration	1.4 kW / 230 VAC
Fuse	T800 mA; T125 mA; T6,3 A
Over-voltage category	II
Ingress protection	IP30
Operating temperature	+5 to +40 °C
Weight	6.7 kg
Installation	wall mounted
Relay output contacts	230 V / 1,4 kW
Discharge of dosing pumps	60 ml / min / max. 1bar
Measured water pressure	max. 1 bar (must not be vacuum)
Dimensions	430 x 330 x 160 mm



# Installation Test

**WARNING:** Any obstacles, bubbles or leaks in the connecting tube will prevent DOS-COMPLETE from correct operating. The clear plastic tube allows you to monitor flow of liquid to the injecting valves.

Before commencing the operation, test DOS-COMPLETE installation.

**Most problems result from incorrect installation.**

## Test

In the “Relay Test” menu, start pumps one by one and while they are running, check tightness of all the PE tube connections. Check the injecting valves for blockage and air bubbles in the PE tube.

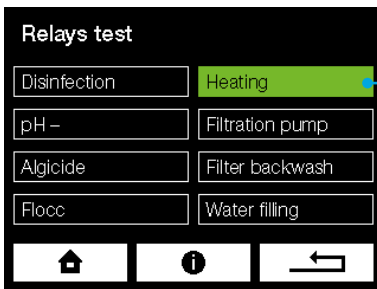

Press to **TURN ON (GREEN)** and press again to **TURN OFF**.

**DON'T FORGET!** After you complete the test, stop all accessories in the menu. Do not dose in this step!

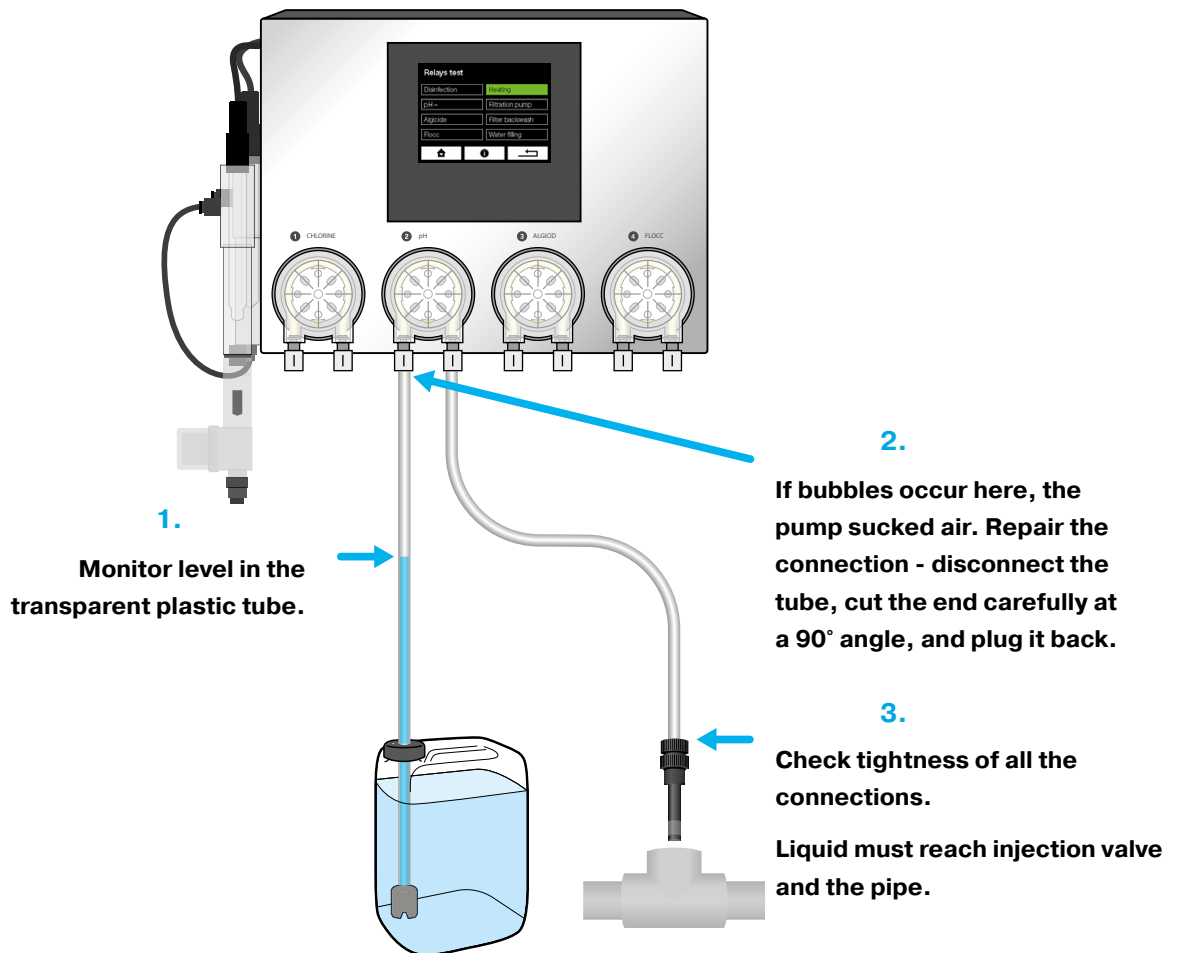

# Touch screen description

## Home screen

The home screen displays measured values, required values and status information.

E.g. click on the **Chlorine** to enter the setting of the required chlorine value.

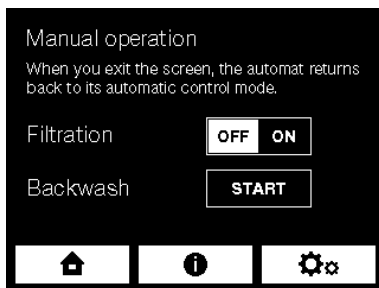
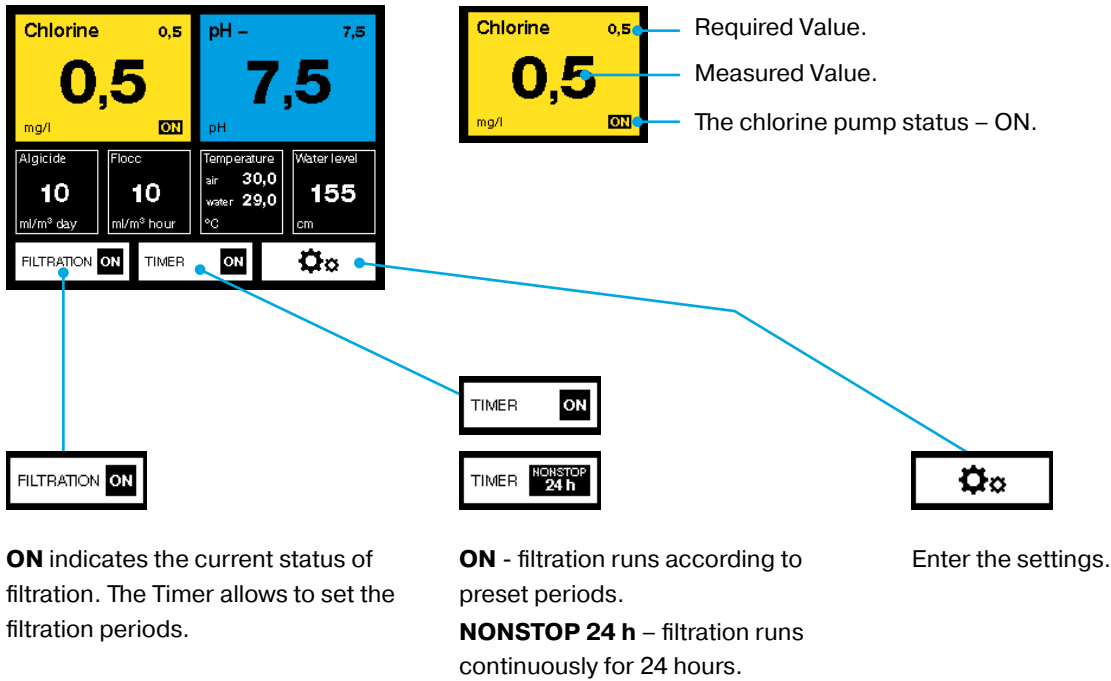

Manual control allows to:

- switch filtration on/off** independently to preset filtration periods.
- start filter washing** independently to preset backwash periods.

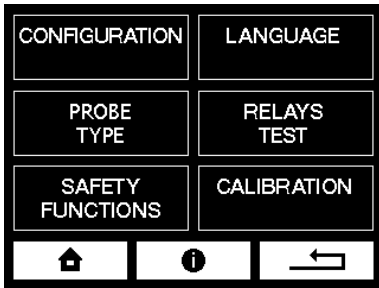

## Settings



Back to the home screen.



More information for current screen.



Back to the previous screen.

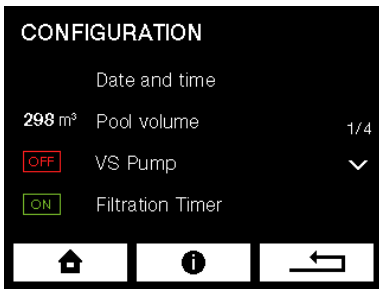

## Movement through menu



Movement in menu to the previous page.

Indicator of the current page and the total number of pages.

Movement in menu to the next page.



ON - function is switched on



OFF - function is switched off

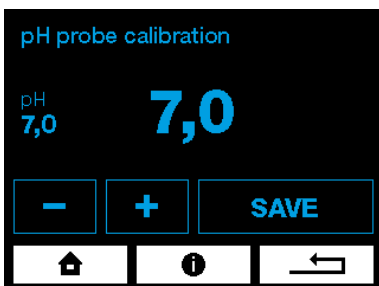

## Value settings



Decrease the value.



Increase the value.



Save the set value

# Configuration

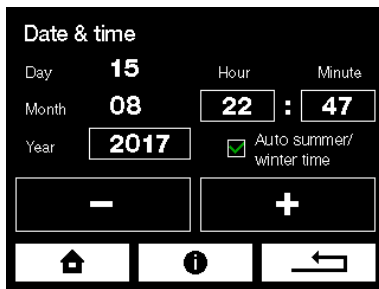

## Date and time

To ensure the correct function of timers, set the current date and time.

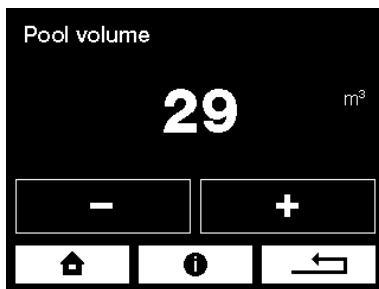

## Pool volume

To ensure the correct function of DOS-COMPLETE, enter the correct volume of your pool. Calculate your pool volume in m<sup>3</sup>:

Length (L) times width (W) times depth (D) is volume (V) - (L × W × D = V).

Enter the value using + and - buttons.

**WARNING:** The pool volume has effect on the maximum safe dose, enter the value correctly.

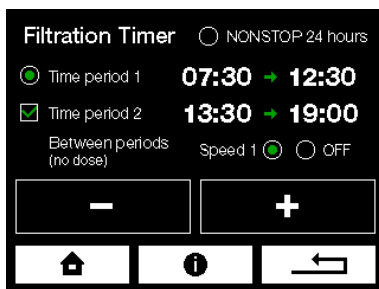

## Filtration timer

Filtration timer can be set to NONSTOP 24 hours operation, or to one or two filtration periods.

### Between periods (requires VS pump)

DOS-COMPLETE allows you to control the variable speed circulation pumps. The variable speed pump runs at speed 2 during filtration periods. Outside of filtration periods, when the standard circulation pump is off, the variable speed pump can run at speed 1 or be OFF (depending on its setting).

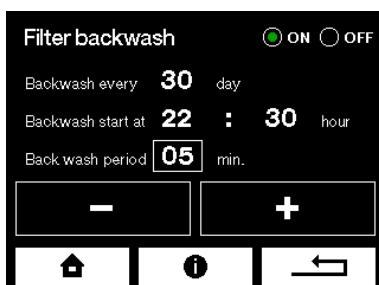

## Automatic filter washing

Given that the technology of the water treatment system is based primarily on high filtration performance and the effectiveness of removing even the finest impurities, it is necessary to rinse the filter regularly. With the automatic backwash function, this function is carried out quite conveniently and independently.

To use this function, an Aquastar Easy 2 is required, but alternatively the backwash also works with an Aquastar Control.

## Smart heating

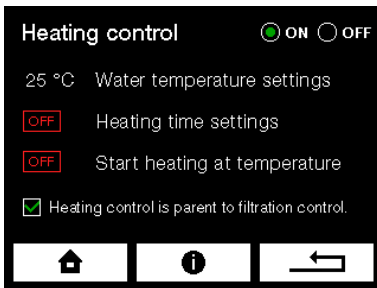

### Water Temperature Measurement and Heating Control

The water thermometer should be installed in the inlet pipe coming from the pool. Never install it behind the heat exchanger. When the temperature drops below the required value, the relay switches ON your heat source (heat pump, electric heating, gas boiler circulating pump).

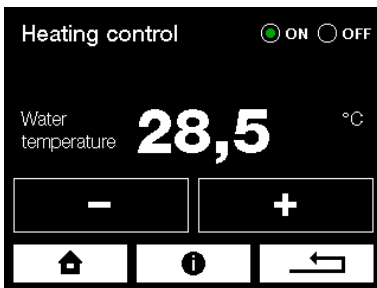

### Heating control function takes priority over filtration control

If you select the option heating control is parent to filtration control, then the water temperature takes priority over the filtration timer. The heating as well as the circulating pump will be running even outside of the set filtration periods. The pump and the heating stop only when the required temperature is reached.



### Heating time settings

This function allows to set a time for which the heating will be in operation. This is particularly useful for switching on the heat pumps which have a higher efficiency during the day when outdoor temperature is higher. Eventually, turn off the heat pump during a specific time to reduce the noise from the heat pump.

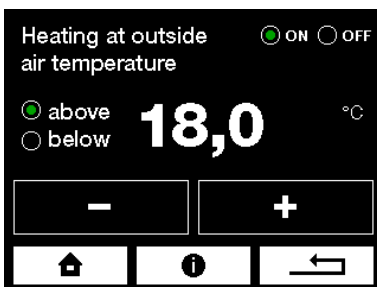

### Heating at outdoor temperature (above or below)

This feature allows you to set the outdoor air temperature, at which or below which DOS-COMPLETE starts heating. To use this feature, an outdoor air thermometer must be installed. This function is used to optimize the effectiveness of air heat pumps, which have higher efficiency at higher temperatures.

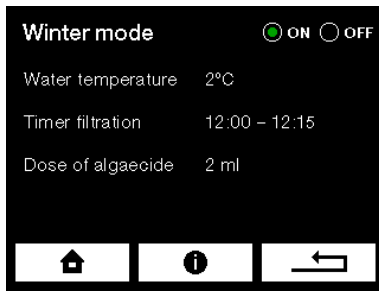

**WARNING: DO NOT  
USE HEAT PUMP IN THE  
WINTER MODE!**

**Winter mode does not  
protect the heat pump from  
freezing.**

**Disconnect the heat pump  
and winterize it separately.  
Follow the heat pump  
manufacturer's manual.**

## Winter mode

Activating this function set the device into the special Winter mode. This mode prevents the pool water from freezing and keeps the water clean with dosing of algaecide.

**In the Winter mode following function are deactivated:** chlorine dosing, pH dosing, flocculant dosing, water filling, filter backwash. **Water flow is set to the bottom drain.**

Every day the filtration pump runs in preset filtration timer.

Outside of the filtration timer the filtration pump remains OFF (VS pump SPEED 0) but is automatically activated for the period of 15 minutes when the outdoor temperature drops below 0°C.

- If, after the period of 15 minutes, the water temperature is under the set temperature of 2°C, the filtration pump stays ON, and the heating is activated until the water temperature exceeds the set temperature.
- If, after the period of 15 minutes, the water temperature is higher than set 2°C, the circulation pump is turned OFF.

If the outdoor temperature stays below 0°C this cycle is repeated every 6 hours.

When using the Winter mode without the **outdoor air thermometer**, the system acts as it always detects 0°C outdoor temperature.

**Warning:** Winter mode must not be used with the heat pump. The entire system is programmed that it does not protect the heat pump against freezing in the event of severe frosts. The winter mode can only be used in fully inground (thermally isolated) pools with filtration technology located in a non-freezing environment. The winter mode cannot be used for above-ground pools



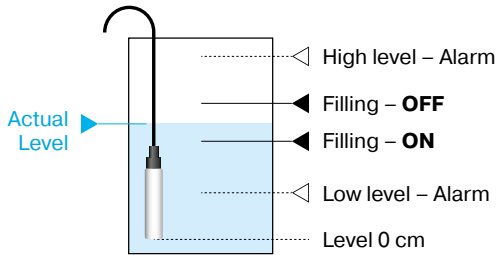
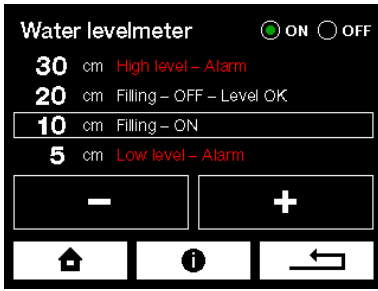

## Level sensor - level monitoring and automatic refilling

The water level is monitored using a pressure-type level sensor, which is easy installed by inserting the probe into the buffer tank or the blind nozzle of skimmer pools. DOS-COMPLETE monitors four different levels, which can be set in centimeters in the water level meter menu.

### Setting:

#### High level ALARM - too much water in buffer tank

After this level is reached, following actions may start:

1. If the automatic filter backwash is enabled, one backwash cycle starts and drains the waste water.
2. If the automatic filter backwash is not enabled, the relay 19 switches on (filter backwash) for the period of time until level is OK. The second circulating pump or automatic drain valve can be connected to this relay.

#### Refilling OFF - required level

Refilling stops

#### Refilling ON - level at which refilling starts

Refilling starts after if the water level stay permanently at least for 10 seconds below this value (in order to prevent oscillating)

#### Low level ALARM

Circulation (filtration) pump shuts off

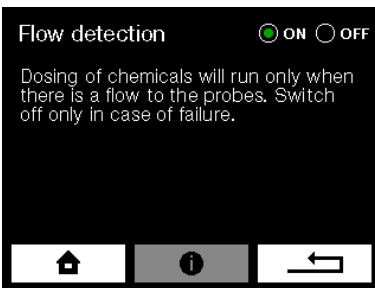

## Flow detection

The flow detector detects flow of measured water. Dosing of chemicals will take action only if the water flow to probes is detected.

**Warning:** Only switch off the flow detector in case of a failure.

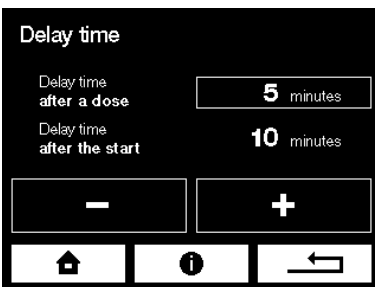

## Delay

**Delay time after dose** is time for which DOS-COMPLETE does not dose and wait for the response of probes. The average response time is 4 to 10 min, at SPA 1 to 10 min.

**Delay time after start** of the filtration pump (upon timer switching on) is time after start for which DOS-COMPLETE does not take any action and waits for stabilization of a signal from probes.

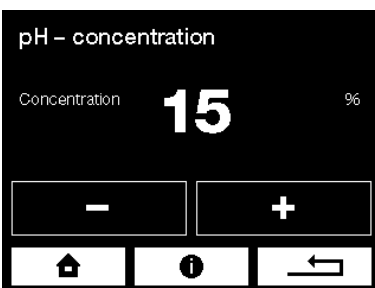

## Concentration pH –

If you use the original ASEKO Pool & SPA chemicals keep the preset value. In case of use of non-original chemicals adjust concentration according to data on the label of a chemical used.

**Warning:** Higher concentrations of chemicals can result in shorter lifetime of DOS-COMPLETE components and may cause injury and health damage.

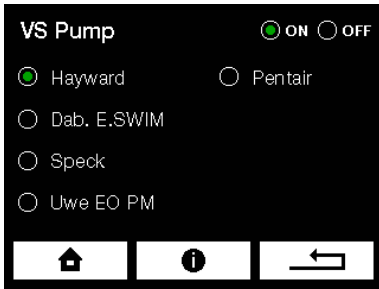

## VS variable speed pump control

In the settings, select the type of your variable speed pump. DOS-COMPLETE allows you to use 4 speeds of your VS pump.

Speed 0 (OFF)

Speed 1 (LOW) for economical filtration outside the TIMER.

Speed 2 (MEDIUM) for filtration during TIMER periods.

Speed 3 (HIGH) during filter backwash.

By default, the variable speed pump runs at speed 2 during filtration timer periods. Outside of the filtration timer periods, when the standard circulation pump is off, the variable speed pump can run at speed 1 or be OFF (depending on its setting). During filter backwash, the pump is automatically set to speed 3.

Individual speeds are set directly on the pump according to the pump manufacturer's manual.

## Programmable relay

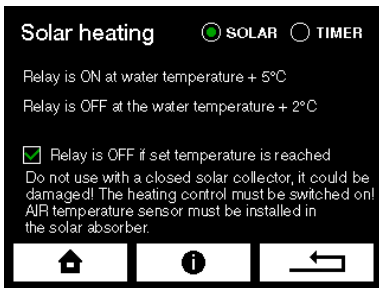

### Solar heating

To use this function, in the menu **PROGRAMMABLE RELAY** choose the option **SOLAR**. **Connect the air thermometer to the solar absorber** and to the POTENTIAL-FREE relay TIMER / HEATING connect what is to be controlled by the relay.

Once the temperature of the solar absorber is **5 °C higher** than the temperature of the water, DOS-COMPLETE activates the relay which starts the circulation of the water to the solar absorber. When the temperature of the solar absorber is not 2 °C higher than water temperature the relay is deactivated.

When using both solar heating and the heat pump simultaneously, SMART HEATING gives the option to automatically disable the heat pump, utilizing only solar absorbers to optimize electrical consumption.

- In the HEATING CONTROL menu go to the Heating at Outdoor Temperature (above or below) and check the HEAT BELOW option. Set the temperature between 30 to 40 °C.

**WARNING:** With use of solar collector set the filtration timer through all the hours of sunshine to prevent overheating of the solar collector.

**WARNING:** In order to activate this function, heating control must be switched ON.

**WARNING:** Air thermometer must be connected to the solar absorber.

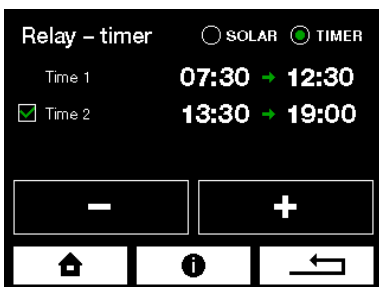

### Timer

To use this function, in the menu **PROGRAMMABLE RELAY** choose the option **TIMER**. One or two intervals can be set for the activation of the relay. Connect what is to be controlled by the TIMER to the POTENTIAL-FREE relay Timer / Heating.

Aquastar® Easy 2  
incl. pressure sensor



# Integration automatic Aquastar® backwash valve

To use this function, an Aquastar Easy 2 is required, alternatively the backwash also works with an Aquastar Control

1. Connect the Aquastar Easy II according to the following diagram

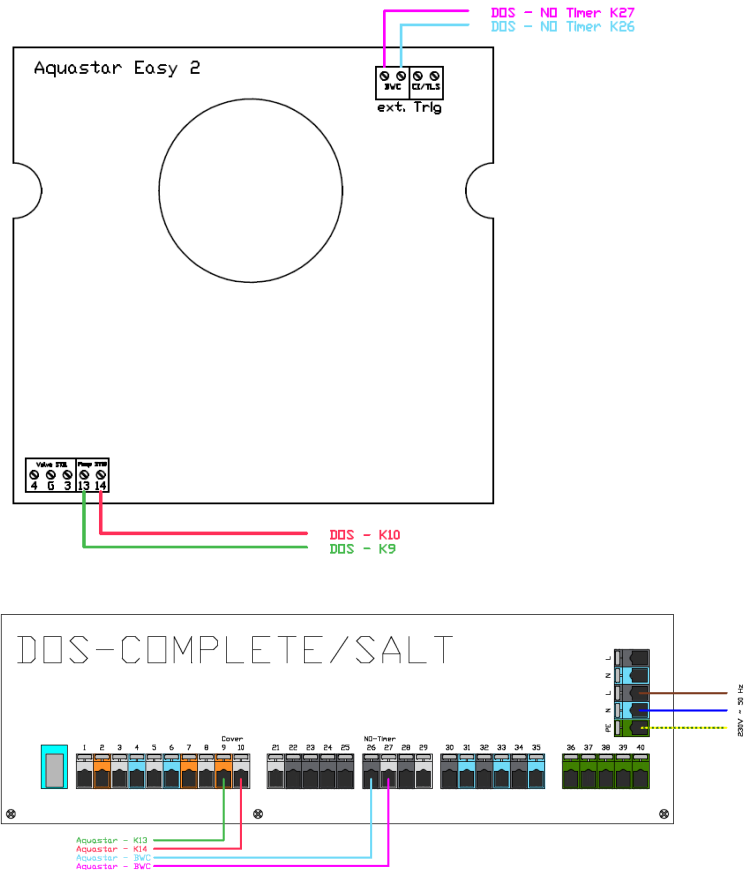

2. In the dosing system or salt system you must activate the filter backwash and set the time of the backwash
3. You must set the backwash parameters (duration of backwash, duration of post-rinse) directly in the Aquastar Easy II using the slide switches. **IMPORTANT: "Backwash switching points" must be set to OFF, as this control is taken over by the dosing or salt system.**

### 15 Backwash time Switch SW1

The backwash time is set with the switch SW1 on the control board.  
Four backwash times are available.

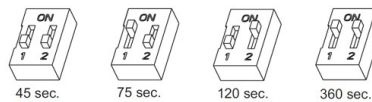

### 16 Rinsing time Switch SW2

The rinsing time is set with the switch SW2 on the control board.  
Four rinsing times are available.

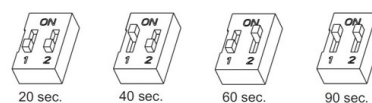

### 17 Switchpoints backwash time Switch SW3

The switch points for backwash time are set with switch SW3 on the control board.  
Four switch points for backwashing are available.

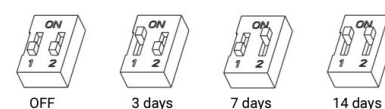

# Choosing the type of probe or the type of time dosing

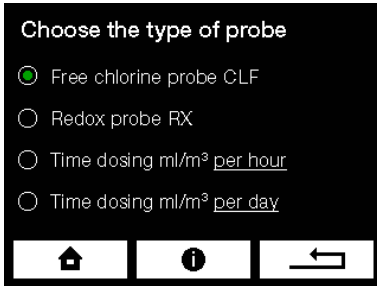

1. **CLF free chlorine probe** for DOS-COMPLETE CLF  
Free chlorine measurement, CHLOR PURE dosing



2. **Redox probe** for DOS-COMPLETE Redox  
Measurement of redox potential, CHLOR PURE dosing



3. **Time dosing** without probe for DOS-COMPLETE OXY  
Timebased dosing of OXY PURE

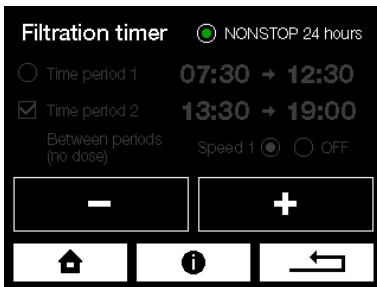

# Commissioning procedure and required value setting

## Commissioning procedure

The water in the pool must be clean without any additives. Ideally fill the pool with fresh water from the water main.

- Set the Filtration timer to NONSTOP 24 hours
- If you have the CLF probe, set the disinfection to 0.0 mg/l.  
If you have the REDOX probe, set the disinfection to 000 mV.  
If you have the Time dosing set the required value of OXY Pure to 0 ml/m<sup>3</sup>/day.

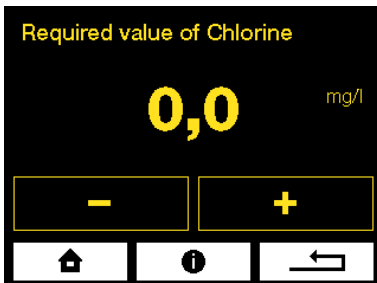

**CLOSE**



## Close the water supply to the probes

DOS-COMPLETE displays no flow to the probes.



SuperCHLOR  
#13120

## Perform shock chlorination

Perform shock chlorination of pool water with Super CHLOR (inorganic active chlorine without stabilizers).

Follow the instructions on the packaging (1 kg = 80 m<sup>3</sup>).

## Before opening the water supply to the probes

### 1. DOS-COMPLETE CLF or Redox

The water must be **clean** and the **chlorine concentration** measured by the digital tester must be between **0.3 and 1.2 mg/l**. If the **concentration is lower**, repeat shock chlorination. If the **concentration is higher**, wait till the chlorine concentration in the water drop down.

### 2. DOS-COMPLETE OXY

**Wait 24 hours.**

**OPEN**



## Open the water supply to the probes

Warning No flow to probes turns off automatically.

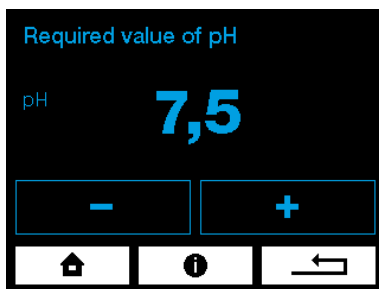

### pH setting

Considering that the DOS-COMPLETE water treatment system is efficient in the broad pH range, it is recommended to enter the required pH value equal to pH value of water you refill or slightly lower.

**Required pH value = refilled water pH value (in the range from 6.8 to 7.5)**

pH may change during operation but if it is in the range from 6.8 to 7.5 you do not have to change this setting.

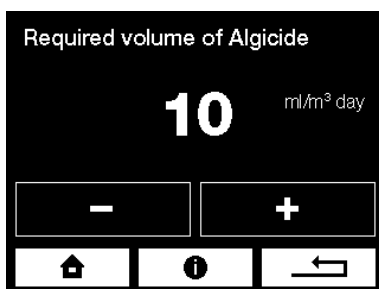

### ALGICIDE setting

A sufficiently effective dose for most pools is 10 ml/m<sup>3</sup> per day. If green algae appear in the pool, you can increase the dose. After algae have disappeared, the dose can be returned to 10 ml.

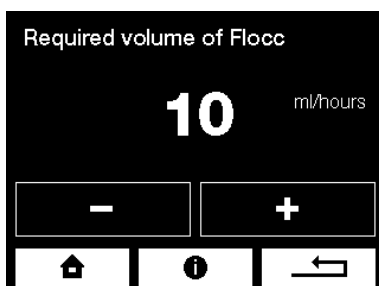

### FLOC+C setting

The FLOC + C dose is calculated from the amount of circulating water, which flows through the filtration.

Based on your circulating pump power (in m<sup>3</sup> per hour), adjust the FLOC + C dose value. E.g. with the circulation pump with power of 10 m<sup>3</sup>/h set the FLOC + C dose to 10ml/h. This value ranges from 10 to 40 ml per hour for most private pools.

# If you use the CLF probe

For the correct functionality of the CLF probe you must observe the following conditions:

## pH of the pool water

The pH value should be between **6.8 and 7.5**.

**The pH of the pool water must be stable.**

If the pH value fluctuates, the value of the chlorine changes accordingly.

Chlorine content mg/l	Water temperature
0.3 to 0.5	24 to 26 °C
0.5 to 0.8	26 to 32 °C
0.8 to 1	Over 32 °C

## Determination of the required chlorine value in pool water

The required concentration of chlorine in pool water varies with the temperature of the pool water. However it should never be less than 0.3 mg/l.

Determine the required value using the table on the left.

### WARNING

Before proceeding to setting of the required values, keep the probe connected to the water for at least 1 hour, ideal 24 hours, to stabilize its measurement.

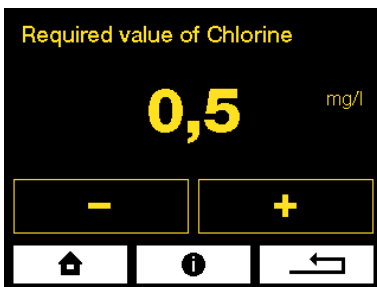

## How to set the required chlorine value

Use a colorimeter or digital Pool Tester to measure the chlorine value in pool water sample.

If the chlorine concentration (measured with a colorimeter or digital Pool Tester) is:

- **ADEQUATE** to the value shown on the DOS-COMPLETE, your device is ready to maintain the required concentration of chlorine in pool water.
- **BELOW** the required value shown on the DOS-COMPLETE, **increase** the required value **by 0.1 (by 0.2 mg/l max)** (regardless of the required value according to the table).

Repeat the measurement after the water in the pool is mixed thoroughly and the value shown on the DOS-COMPLETE is stable.

Repeat the process until the **chlorine concentration in pool water matches your required value** then set the correct required value according to the table. Additionally, you can perform the calibration of the CLF probe (see the chapter CLF Probe Calibration).

- **HIGHER** than the required value shown on the DOS-COMPLETE display - you can calibrate the CLF probe (see the chapter CLF Probe Calibration).

### NOTIFICATION:

Fix the **low chlorine value** in pool water by **increasing required disinfection value on the display of the unit.**

**RECOMMENDATION:** Check the chlorine value in the pool once a week using the colorimeter or digital pool tester.



# If you use the Redox probe

For the correct functionality of the REDOX probe, you must observe the following conditions:

## pH of the pool water

The pH value should be between **6.8 and 7.5**.

**The pH of the pool water must be stabilized.**

If the pH value fluctuates, the value of the Redox changes accordingly.

Chlorine content mg/l	Water temperature
0.3 to 0.5	24 to 26 °C
0.5 to 0.8	26 to 32 °C
0.8 to 1	Over 32 °C

## Determination of the required chlorine value in pool water

The required concentration of chlorine in pool water varies with the temperature of the pool water. However it should never be less than 0.3 mg/l. Determine the required value using the table located on the left.

### WARNING

Before proceeding to setting of the required values, keep the probe connected to the water for at least 1 hour, ideal 24 hours, to stabilize its measurement.

## How to set the required Redox value

Set the required REDOX value to **650 mV**

Use the tester to check if the **chlorine content in pool water is within the range of 0.5 - 1.2 mg/l**.

## Fine-tuning

Use the colorimeter or Pool Tester to measure the chlorine value of the pool water. If the manually measured chlorine value in pool water is:

- **ADEQUATE**, your DOS-COMPLETE is ready to maintain the required concentration of chlorine in pool water.
- **LOW**, increase the required REDOX mV value in the menu.
- **HIGH**, reduce the REDOX mV value in the menu.

**Every 10 mV corresponds approximately to 0.1 mg/l of chlorine in the pool water.**

### EXAMPLE:

The chlorine value in the pool water is 0.3 mg/l - the displayed value is 650 mV. If you want to increase the chlorine value to 0.5 mg/l. You have to increase the preset value of the redox by 20 mV to 670 mV.

### NOTE:

The relationship of Redox potential and chlorine value in pool water cannot be determined by the exact table. The correct value of the Redox must be observed by several check measurements.

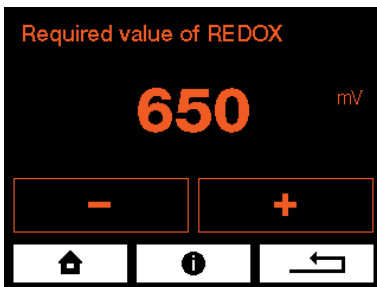

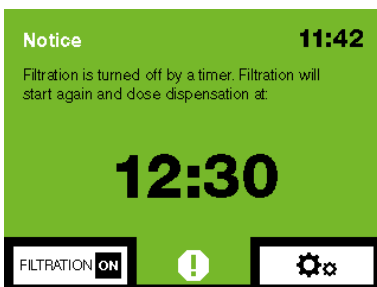
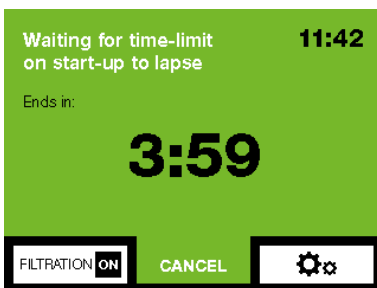
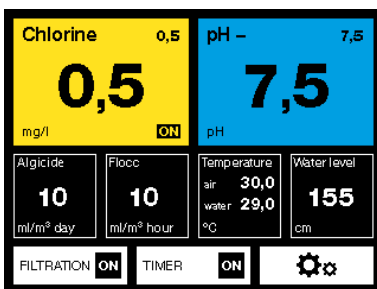
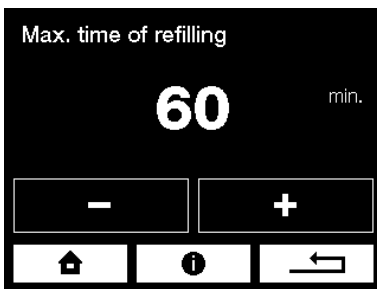
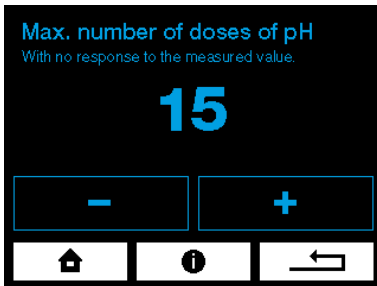
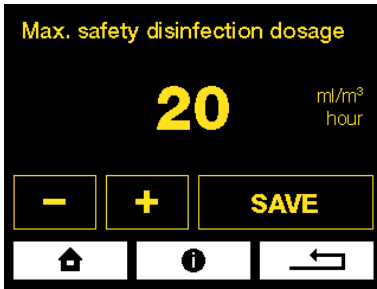

# Safety functions

## Safety disinfection dosage - without probe response

If the measured disinfection value does not increase after preset maximum safety disinfection dose (according to the settings), DOS-COMPLETE stops disinfection dosing and an error message appears on the display.

The other DOS-COMPLETE functions are not limited.

The error message must be canceled manually.

## Maximum number of pH doses - without probe response

If the measured pH value does not decrease even after preset maximum number of doses (according to the settings), DOS-COMPLETE stops pH dosing and an error message appears on the display.

The other DOS-COMPLETE functions are not limited.

The error message must be canceled manually.

## Maximum refilling time

Maximum time to reach the required water level. If the water level is not reached within the preset maximum refilling time an error message appears.

# Operation

In standard automatic mode, only these 3 screens are displayed.

## Home screen

## Delay after start

DOS-COMPLETE does not dose and waits for the probes to stabilize and the pool water to mix.

## Filtration is turned off by the timer

# In operation measurement and calibration

**Calibration is not possible when the new value differs by more than 1 from the non-calibrated value.**

**The pH probe can only be calibrated in the pH range of 6.2 to 7.8.**

**The pH probe cannot be calibrated when the LOW or HIGH warning is displayed.**

## pH probe calibration

When pH is being measured in operation, there may be a difference between the value measured by DOS-COMPLETE and the actual pH value in water. Proceed to the calibration.

## pH Probe Calibration menu

### Non-calibrated value

The pH probe calibration menu always displays the original non-calibrated value. Calibration of the pH probe is not possible when the new value differs by more than 1 from the non-calibrated value. If the difference from the non-calibrated value exceeds 1, the probe should be sent for inspection or replaced with a new one.

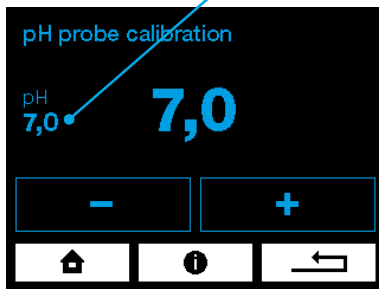

pH 7.00 Buffer



Lovibond® Scuba3s Multiparameter Pool Tester



## pH probe calibration process

Calibration can be done in two ways:

### 1. With a buffer

- **Close the water supply to the probes.**
- Remove the probe from DOS-COMPLETE : rinse the probe with clean water and wipe it.
- The probe must remain connected to the device via the cable. Dip the probe in the calibration buffer and after the value displayed on DOS-COMPLETE is stable, enter the buffer value into the pH Probe Calibration menu.

### 2. With a colorimeter or Pool Tester

- **The water supply to the probes must be open**
- Measure the pH value directly in pool water using a colorimeter or Pool Tester.
- Then enter this value into the pH Probe Calibration manu. Calibration can be performed in the range of 6.4-7.8.

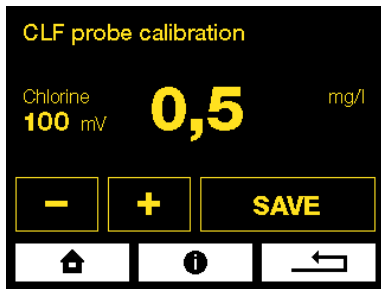

## CLF probe calibration

**Do not calibrate the probe until** the water in the pool is thoroughly mixed and **the value displayed on the DOS-COMPLETE is stable.**

**This may take several hours.**

**Perform calibration of the CLF probe when the manually measured value of free chlorine is equal to or higher than the value you are calibrating to.**

Calibration is performed by entering the manually measured value of chlorine concentration (using a photometer) in the CLF Probe Calibration menu.

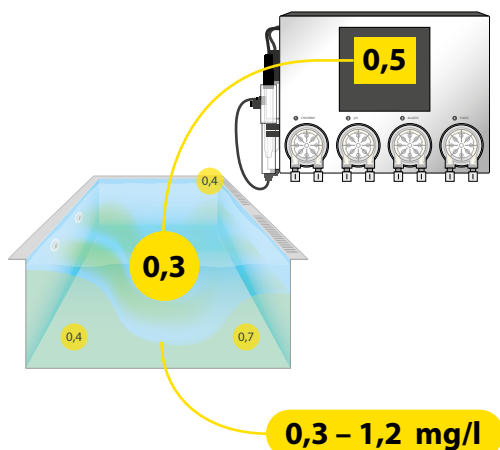

Calibration **is not necessary** if the difference between the photometer measured value and the value shown on the display **is less than 0.2 mg / liter.**

Calibration is best performed with chlorine concentrations in the pool water in the range of **0.3 - 1.2 mg / l.**

### Calibration restrictions

The CLF probe cannot be calibrated if the output **signal is less than 20 mV.**

The CLF probe can only be calibrated in the CL range **from 0.3 to 5.0 mg / l.**

#12177 OX tester



## Adjustment of OXYPURE active oxygen dose

When using chlorine-free technology DOS-COMPLETE OXY the optimum OXYPURE concentration value is from **50 to 100 mg**.

From time to time check this value by measuring with the OX tester and adjust the dose in the menu, if required.

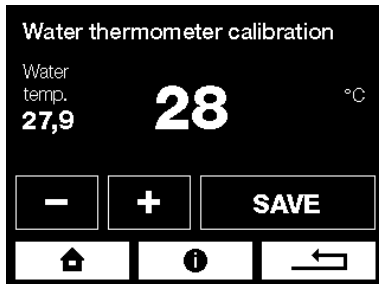

## Water thermometer calibration

If the temperature of water in the pool is different from the temperature shown on DOS-COMPLETE, calibrate the water thermometer in the water thermometer calibration menu.

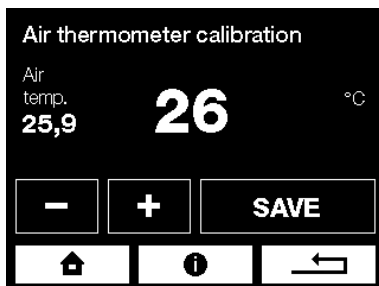

## Air thermometer calibration

If the temperature of air is different from the temperature shown on DOS-COMPLETE, calibrate the air thermometer in the air thermometer calibration menu.

## Stabilizer in water

**The water in the pool must be clean without any additives. Ideally fill the pool with fresh water from the water main.**

BALANCER #13039



## Alkalinity

Alkalinity volume in the water should range from **80 to 120 ppm**. Alkalinity stabilizes the pH and reduces its consumption. To increase the Alkalinity in the water, use **Pool & SPA BALANCER** (#13039).

## Cyanuric Acid

The value of Cyanuric acid must be **0 ppm**. Cyanuric acid greatly diminishes the effectiveness of chlorine, making it difficult to accurately measure and control its concentration. If the presence of cyanuric acid is detected, fill the pool with fresh water.

# Maintenance

Replacement hose  
for the pump PP 60



To ensure the optimum efficiency, perform visual checks and maintenance of DOS-COMPLETE on a regular basis.

## Pump tube replacement

To prevent the pump from failing, it is recommended to replace the tube every 24 months.

**In doing so, proceed as follows:**

- Switch off DOS-COMPLETE.
- Turn the pump cover cassette anticlockwise and take it out of DOS-COMPLETE.
- Release both tube ends and take it out of the cassette.
- Lubricate the new tube with the supplied special grease.
- Insert the lubricated hose into the cassette.
- Place the cover cassette back on DOS-COMPLETE and turn it clockwise to lock it.
- Use new nuts, which are part of the replacement tube set, for connection of the PE tube.

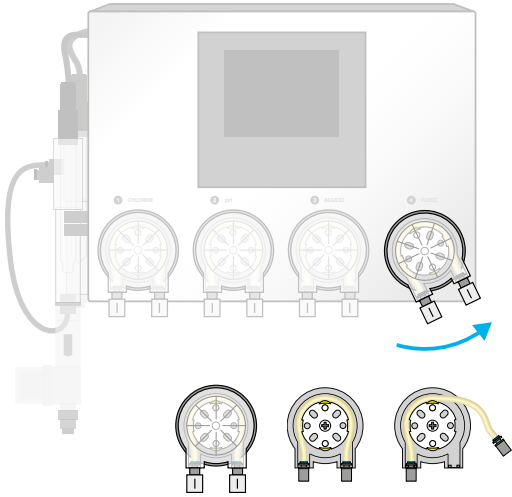

Injection valve



## Injection valve maintenance

On a regular basis, check throughput of the injection valves, rubber band integrity, remove scale.

In case of private pools, replace injection valve rubber bands every 2 years.  
In case of public pools, replace every year.

Replacement rubber band  
for injection valve



Flow detector



## Flow detector with filter

Rinse the filter of the flow detector regularly.

Fuse T 125 mA  
Fuse T 800 mA  
Fuse T 6,3 A



## Fuse replacement

### T125 A fuse

Fuse protecting the inner electronics. In case of its burnout, check the inner electronics.

### T800 mA fuse

Fuse protecting external sensors. In case of burnout of this fuse, check the level sensor, flow detector, and external display.

### T6,3 A fuse

Fuse protecting the device.

pH - Buffer 7,00



## pH probe testing

Take the probe out of DOS-COMPLETE housing and clean it from impurities. Check for visible mechanical damage on the probe.

Measure the pH value and ensure it falls within the tolerance range of +/- 1.0. For example, if the water pH is 7.2 and the probe measures 7.9, it is in tolerance, the probe is considered okay.

Test the probe's response to positive or negative changes in water or buffer by immersing it in a 7.0 pH buffer and observing the response after one minute. The response should be at least 90%.

Follow the instructions in the user's manual for the probe.

## CLF probe testing

The free chlorine probe should output a signal higher than 20 mV at a free chlorine concentration of 0.8 mg/liter.

If the signal is lower, send the probe for inspection.

Conduct a test with clean water without chlorine (standing for 24 hours) and ensure the signal is lower than 20 mV. Otherwise, send the probe for inspection.

Redox Buffer 475 mV



## REDOX probe testing

Take the probe out of DOS-COMPLETE housing and clean it from impurities. Check for visible mechanical damage on the probe.

Ensure that the redox probe's sensitivity does not exceed -12% and that it measures above 420 mV at the buffer value of 475 mV.

Test the probe's response to positive or negative changes in water with 0 chlorine concentration.

**There is no manufacturer of pH and REDOX probes that cover its products with warranty. Peraqua has decided to cover supplied probes to its clients by two year warranty period that cover free repair of supplied probe that will have higher tolerance than above described.**

# Winterizing - storage during winter

If you want to operate DOS-COMPLETE in Winter mode, go to the chapter Configuration - Winter mode. If you do not want to operate the device in Winter mode, it is necessary to winterize the device and all its components (store them when not in use).

## Winterization of the unit and its accessories

If you do not want to have the DOS-COMPLETE device in operation in winter, the device and all accessories must be dismantled, winterized and moved to a suitable location. To disassemble and winterize the DOS-COMPLETE, follow the instructions below.

### Storing of pool chemicals, connecting PE tube and dosing pumps

- If the chemicals are left in a place where the temperature does not drop below 0°C, turn OFF the DOS-COMPLETE. Disconnect the dosing pumps from the DOS-COMPLETE and remove the inner tube from the pump. Leave the tube connected to the connecting PE tube. Put the pump cartridges without the inner tubes back onto the DOS-COMPLETE. Store the chemical barrels and connecting PE tube in a place where the temperature is between +0 - +40 °C.
- If chemicals remain in a location where the temperature drops below 0°C, SWITCH OFF DOS-COMPLETE. Remove the connecting PE tubes from the chemical barrels and place them in a container with water. Turn on DOS-COMPLETE. Go to the RELAY TEST menu and press Chlor/Oxy-pure, pH, Algicide and Floc. When the connecting PE tube is completely filled with water, turn OFF the relay test. Remove the water container and perform the RELAY TEST again to completely fill the connecting PE tube with air. When the connecting PE tube is completely filled with air, stop the relay test and turn OFF the DOS-COMPLETE. Disconnect the connecting PE tubes from the dosing pumps and from the injection valves. Store the chemical barrels in a place where the temperature is between +0 - +40 °C.

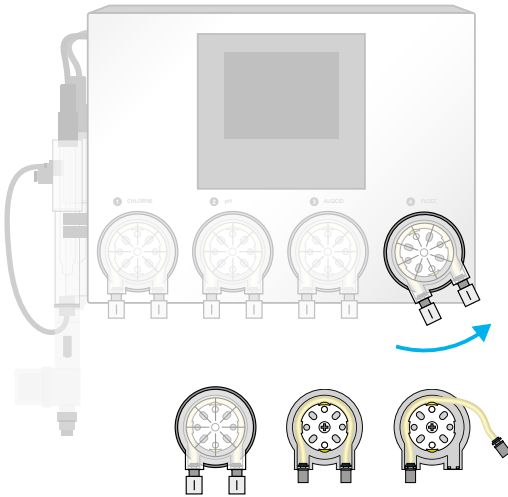

### Disconnect of the DOS-COMPLETE and its accessories

1. Disconnect the DOS-COMPLETE mains cable from the 230 V / 50 Hz socket.
2. Disconnect the filter unit's mains cable from the DOS-COMPLETE and store the filtration pump according to manufacturers manual.
3. Disconnect all accessories from the DOS-COMPLETE motherboard and store them according to manufacturers manual.



Probe storing sump



Probe storing liquid



### Winterizing of probes

#### Winterizing of pH and Redox probe

Remove the probe from the housing, dry it with a paper towel and place it in a storage sump filled with a special storage liquid. See probes manual at the website manuals [www.peraqua.com](http://www.peraqua.com).

#### Winterizing of CLF probe

Remove the probe from the housing, unscrew the membrane and empty the electrolyte from it. Do not put the membrane back on the probe and store them separately in a dust-free place where the temperature is between +5 - +40 °C and the humidity does not exceed 70 % throughout the winter. See probes manual at the website [www.peraqua.com](http://www.peraqua.com).

### Storing of the unit

Move the DOS-COMPLETE unit in a place where the temperature is between +5 - +40 °C and the humidity does not exceed 70 %.

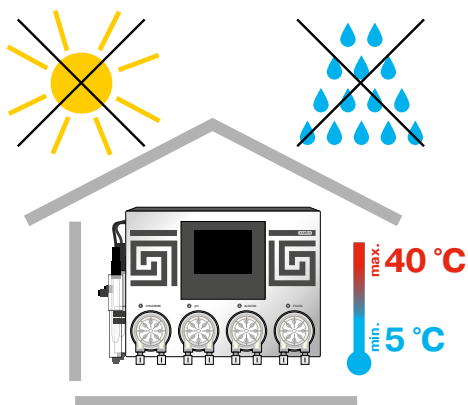

# Internet connection

The LAN connector is to be connected to the domestic router. Data are sent in the intervals of 10 seconds to the address **pool.aseko.com**, the route must not be blocked by the firewall.

If you are not able to setup the connection by your own ask your IT specialist for help.

## Possible connection methods

### Home network

Connect the DOS-COMPLETE to your router via LAL cable.

### Mobile network

In case you have no direct internet access you can use the data transmission over the mobile network. Connect the DOS-COMPLETE to your mobile network router via LAN cable.

### Wifi connection

If you install the DOS-COMPLETE in place where is no access to your private network by wired connection but your Wifi has enough signal, you can connect the DOS-COMPLETE to your Wifi by use of Wifi extender.

### Powerline via 230V/DC

If you have no wired access to your LAN network but your DOS-COMPLETE is in the at the same electric network you can connect the LAN network via 230 V power line socket adapter.

### If you have connection problems:

Please switch off DOS-COMPLETE.

Restart the router and switch on the DOS-COMPLETE again.

The home network must be open to communication on both sides for URL: **pool.aseko.com**

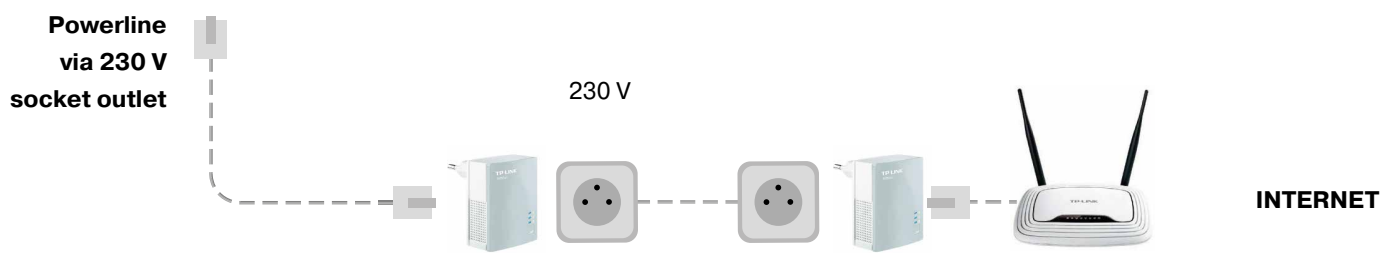
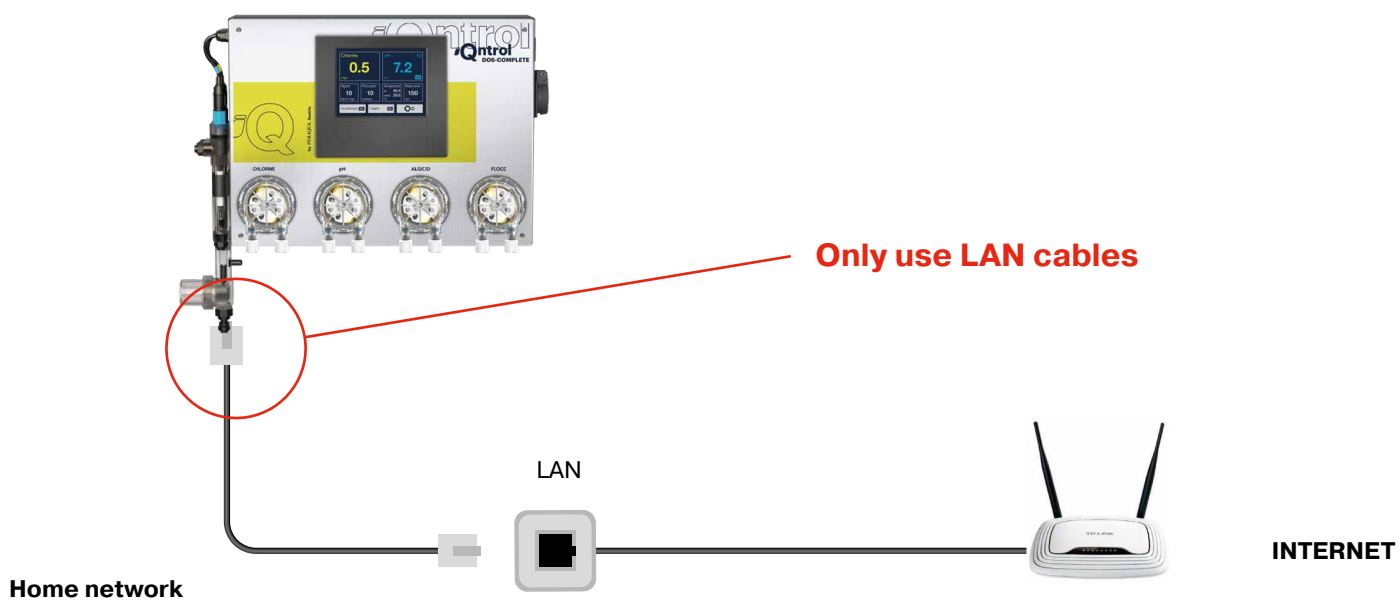

# Web services

## Pool live

The internet connection allows you to use the Pool Live mobile application and monitor your pool on mobile devices wherever the internet connection is available.

After you connect the DOS-COMLETE to the internet download the Pool Live application to your smartphone. Application is available for iOS and Android operation systems.

App's main screen, after opening, will ask for typing your DOS-COMLETE serial number. You can add more units to the Pool live app.

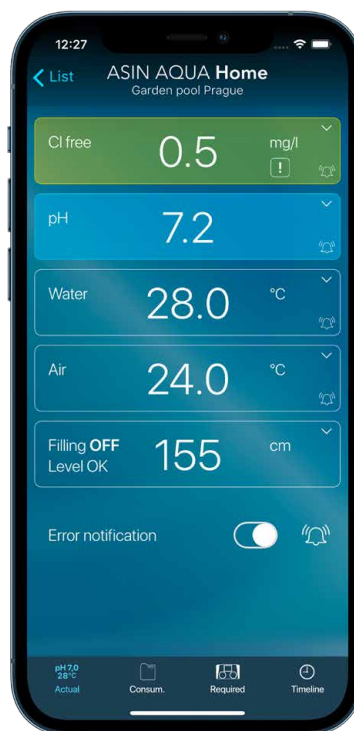
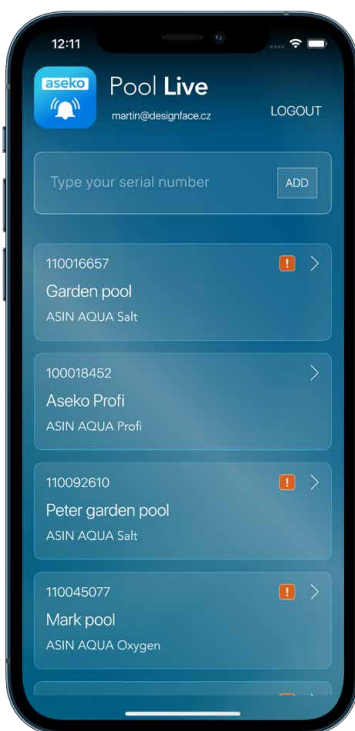

Pool LIVE  
for iOS



Pool LIVE  
for Android



## <https://pool.aseko.com>

The web application for detailed monitoring of the pool water quality by means of well-arranged graphs. It shows all the measured parameters as well as DOS-COMPLETE actions up to 30 days back.

This application is giving you the detailed information of the pool status and detailed review of all events, taken actions and act levels of monitored items up to 30 days back.

Transparent graphic environment of chart lines is giving fast report and you can easily see interconnection of monitored values.

This application is useful at public pool installations where you need to observe the history and monitor the pool water quality and maintenance. In case of any discrepancy in water quality you can find all actions, provided in that moment and in relation to other values you can diagnose the reason of such discrepancy.

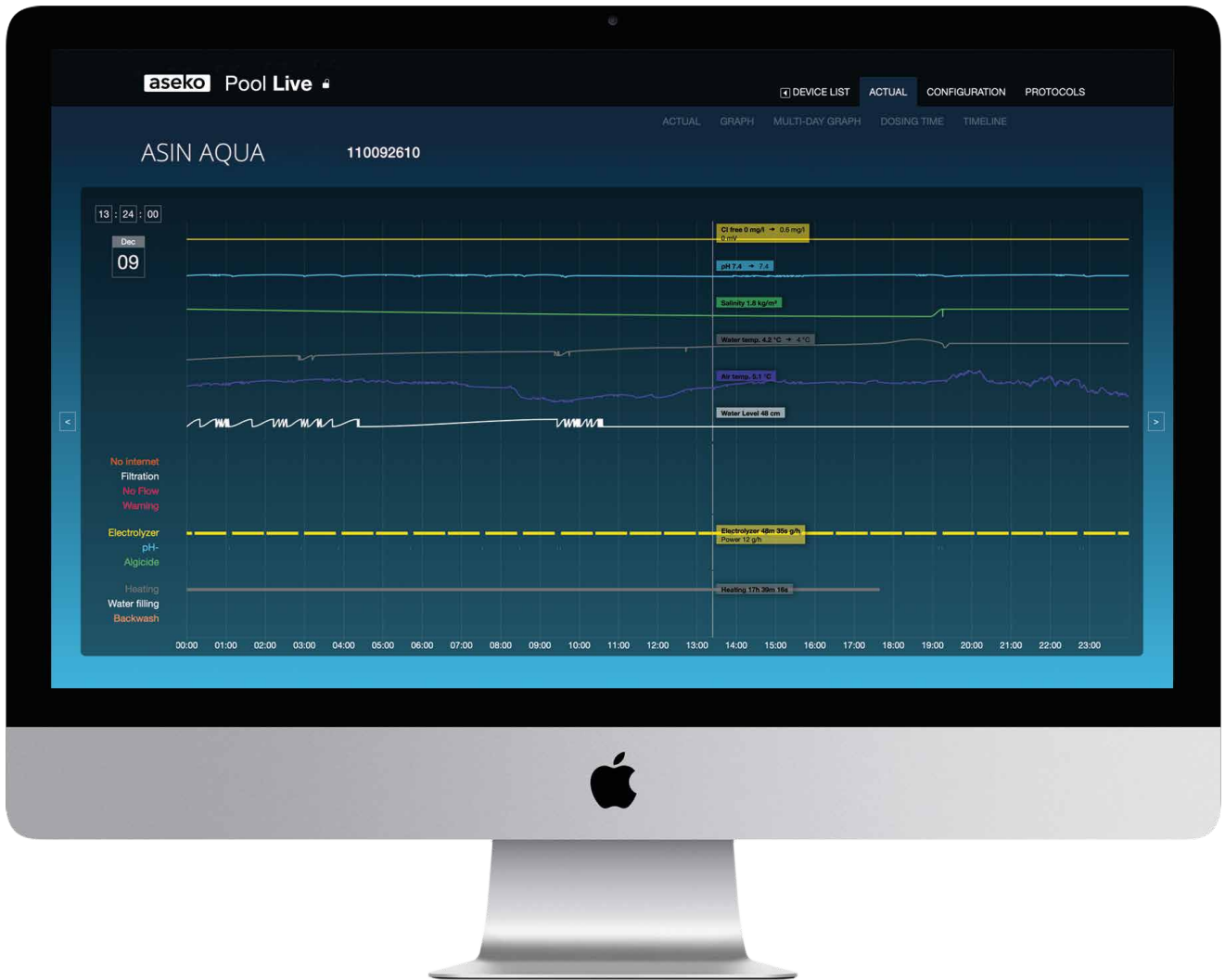

# Error messages

This error message appears after **15/30/60** doses of chlorine without probe response.

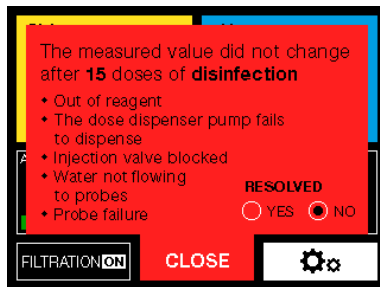

This error message appears after 15/30 doses of pH without probe reaction.

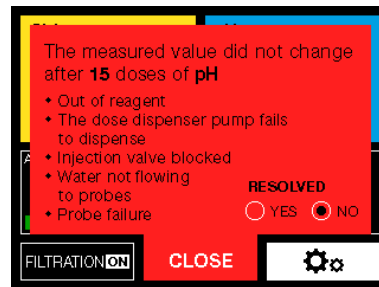

This error message appears when the set maximum chlorine dose is exceeded.

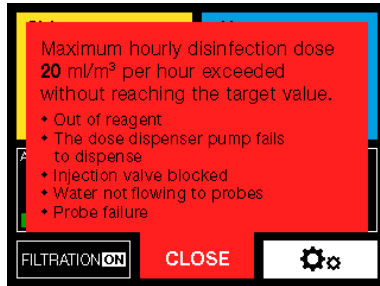

## Those error messages appear when:

### Agent run out

- Check liquid levels on a regular basis, refill in time.

### Dosing pump does not dose

- Leakage in connection of PE tubes or they are damaged.
- Failure of dosing pump. Check whether pump is running. If so, check the hose inside the pump for damage or breakage and replace it, if required.

### Injection valve clogged

- Impassable spray valve.  
Check the valve for being clogged with impurities or deposits or the rubber seal for being damaged.
- Failure of dosing pump. Check whether pump is running.  
If so, check the hose inside the pump for damage or breakage and replace it, if required.

### No water flow to probe

- Check the measured water filter and clean it, if required.
- Check condition of connecting tubes from the extraction valve to the measured water inlet to probes and furthermore, from the water outlet from probes to the closing valve.
- Check condition of the extraction valve and the closing valve and their seals, for being clogged and their closed position.

### Probe out of service

- Measure pH using the hand tester. If the pH value is too low, a respective agent was overdosed due to an incorrect probe function (provided that other reasons given in the previous points have been excluded).
- Take the probe out and check it for mechanical damage.
- Clean the probe following the above procedure.
- It is recommended to replace the probes with the new probes every two years.



### Too rapid pH change

Too rapid change of pH is usually caused by refilling water directly to the skimmer. If such rapid change of pH occur, DOS-COMPLETE stops controlling pH for two hours.

This limitation can be manually disabled.

After pH has been stabilized or two hours have elapsed, DOS-COMPLETE changes over to the normal mode.

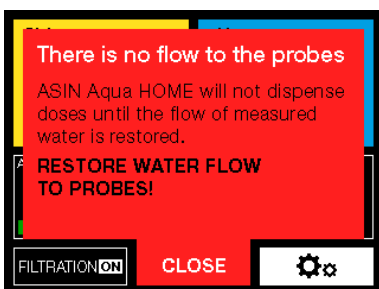

### There is no flow to the probes

No flow to the probes was detected.

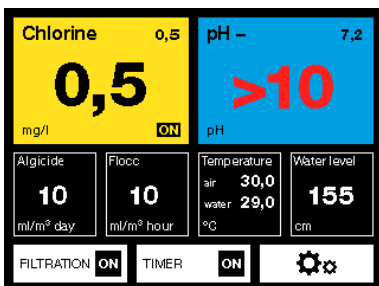

### The probe shows a pH > 10

Check the pool water and probe.

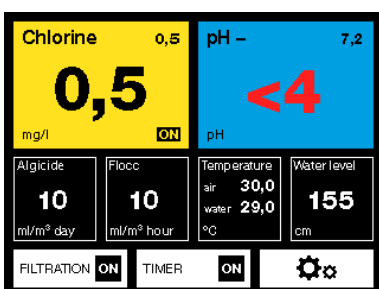

### The probe shows pH < 4

Check the pool water and probe.

# Externes touchscreen display



External  
Touchscreen Display

The external display shows

1. Pool water parameters:  
Temperature, pH value, redox potential or chlorine concentration.
2. Parameters of the air in the pool area:  
relative humidity and temperature.

The setpoints can be set on the DOS-COMPLETE device and a probe calibration can be carried out via the external display.

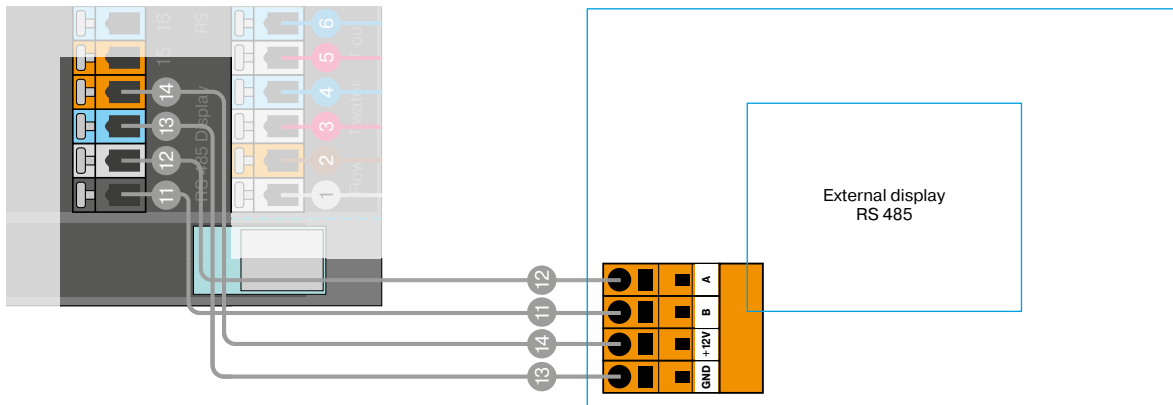



# SPARE PARTS & ACCESSORIES

ITEM NO.	PRODUCT
7301689	REDOX electrode Long Life
7301690	pH electrode Long Life
7301691	CLF electrode
7301693	Replacement rubber injection valve
7301694	Level sensor
7301695	Peristaltic hose set
7301696	Storage liquid for pH and REDOX probes
7301698	Replacement electrolyte for CFL electrode
7301699	Replacement membrane for CLF electrode
7301733	PVC reduction ½" ET to ¼" IT
7301734	Float switch





**PERAQUA®**

[www.peraqua.com](http://www.peraqua.com)

**USER MANUAL  
DOS-COMPLETE**