

Installation - electrical

PERAQUA

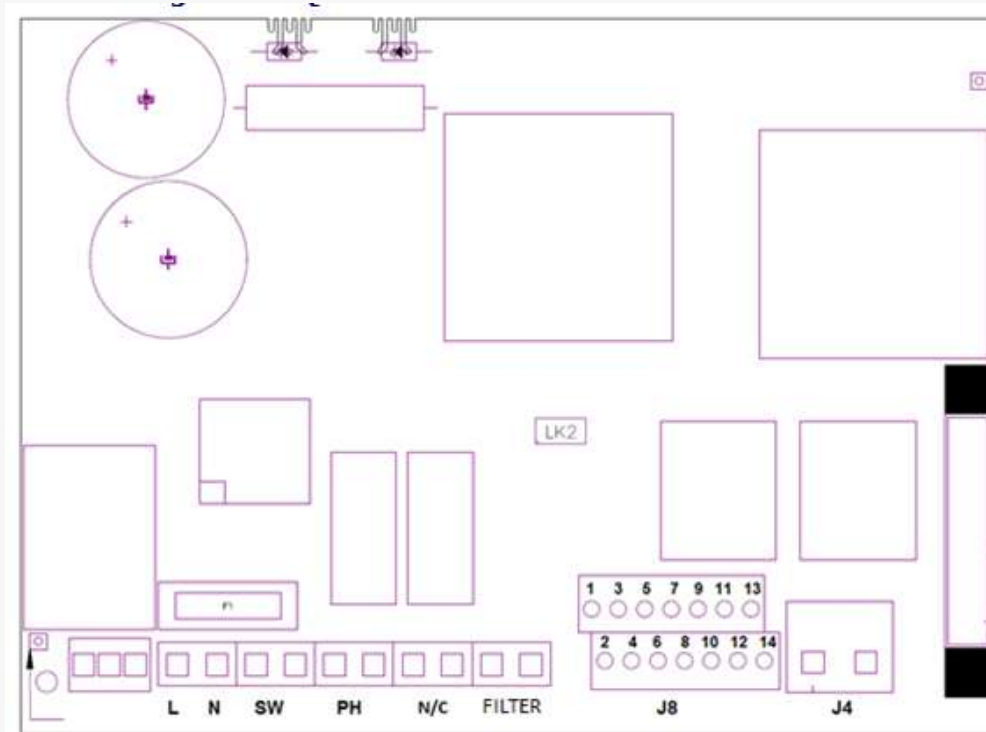

Erdungsanschluss

L, N:	220V-Versorgung
SW:	ON/OFF-Schalter
PH:	pH-Pumpenanschluss (nur bei den Modellen mit AUTO-Set)
RELAIS:	potentialfreies Relais
FILTER:	Filteranschluss für den Betriebsmodus AUS/AN
J4:	Steckerleiste Zellenanschluss
J8:	
1-(gelb)	Säuregehaltssensor (PH)
2-(gelb)	Säuregehaltssensor (PH)
3-(violett)	Abdeckung
4-(violett)	Abdeckung
5-(weiß)	Wasserdurchflusssensor (weißes Kabel der Zelle)
6-(weiß)	externer FLOW-Schalter (5-6)*
7-(blau)	Temperatursensor
8-(blau)	Temperatursensor
9-(braun)	CL-
10-(orange)	CL+
11-(rot)	
12-(grau)	Leitfähigkeit (gnd)
13-(grün)	Leitfähigkeit (Signal)
14-(rot)	12v Leitfähigkeit

*Funktion FLOW-SCHALTER im Konfigurationsmenü aktivieren

K1: pH-Relais

K4: Hilfsrelais

LK2: Start/Stopp (siehe Kapitel 3.3.2.1)

F1: Sicherung

Installation - electrical

PERAQUA

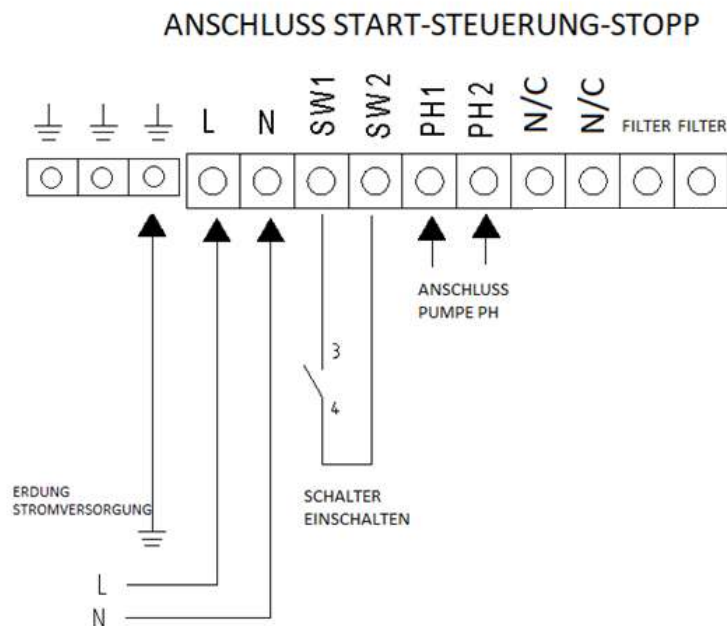

VARIANT 1: WITHOUT FILTER PUMP COMBINATION

Salt system functions independently

DISADVANTAGE: whenever the filter pump is not running, a "no flow" error is issued because the gas sensor is active

... THEREFORE NOT RECOMMENDED

Installation - electrical

PERAQUA

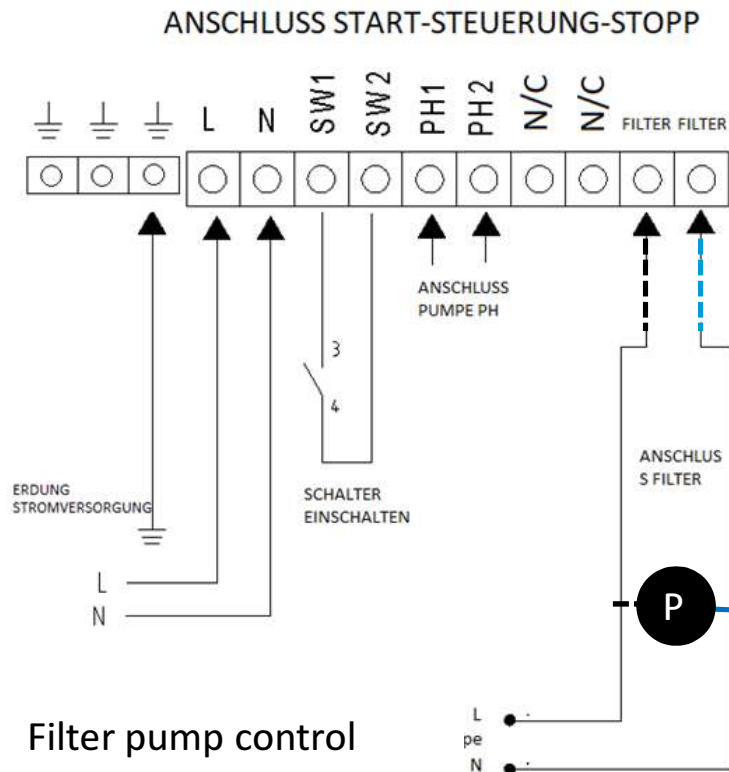

VARIANT 2.0: WITH START-STOP FUNCTION + 230V FILTER PUMP + External pump controller

To do this, remove the jumper on LK2 on the circuit board

And connect the filter pump in parallel to the filter terminals (only one INPUT) - > Filter pump is controlled via a separate filter control unit

The salt system then receives the production release via the filter pump and there are no LOW flow errors

Salt system only active when 230V is applied to filter terminals

Installation - electrical

PERAQUA

Free relay

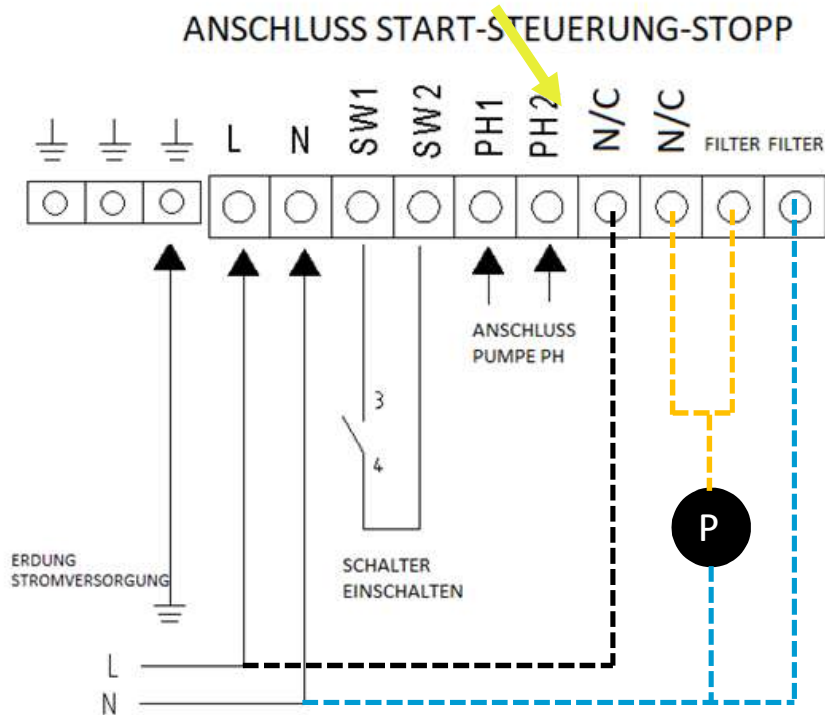

VARIANT 2.1: WITH START-STOP FUNCTION + 230V FILTER PUMP + pump control via salt system

The relay is used to switch the filter input with 230V time-dependent, thus also switching the filter pump ON-OFF

The start-stop control must also be activated again

Pump current < 5A otherwise auxiliary contactor

Installation - electrical

PERAQUA

Free relay

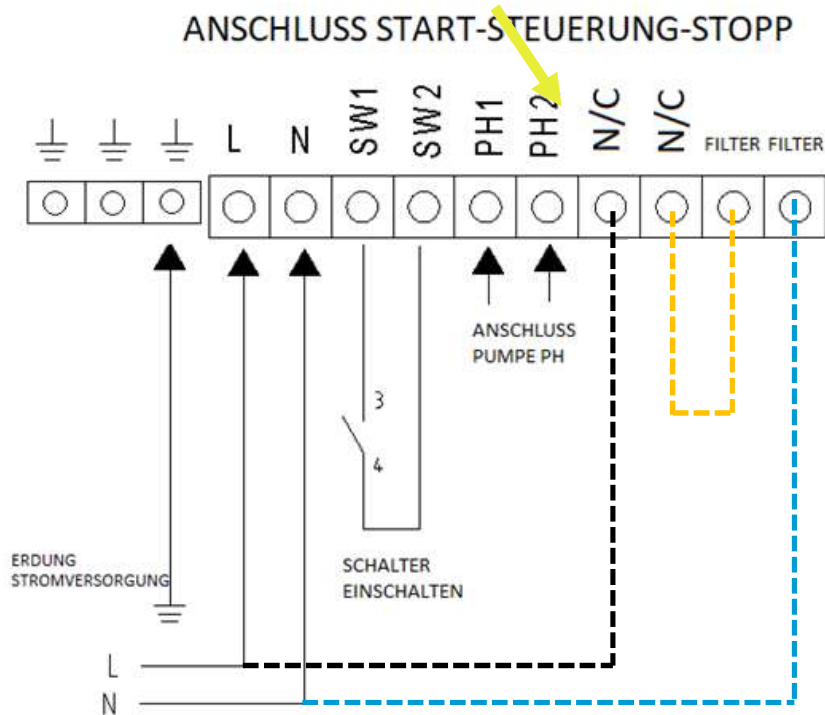

VARIANT 2.2: WITH START-STOP FUNCTION + PUMP where no 230V can be tapped or if there is no connection

The relay is used to connect the filter input with 230 V in a time-dependent manner, i.e. the relay must be programmed in the same way as the filter pump

The start-stop control must also be activated again

Installation - electrical

PERAQUA

Free relay

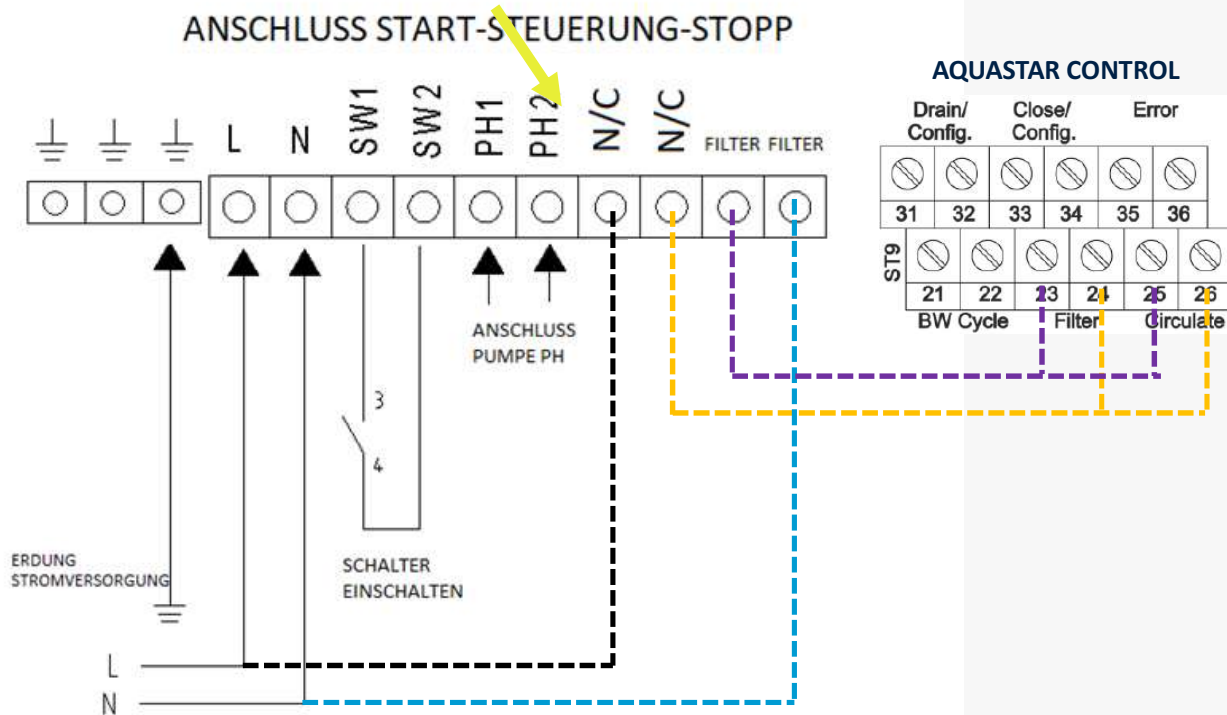

VARIANT 3.0: WITH START-STOP FUNCTION + AQUASTAR CONTROL + PUMP where no 230V can be tapped or if there is no connection

Here, as in 2.2, the filter runtime is also set on the salt system, but the pipe must also be ground via the AS so that the salt system does not run during backwashing

The start-stop control must also be activated again

Installation - electrical

PERAQUA

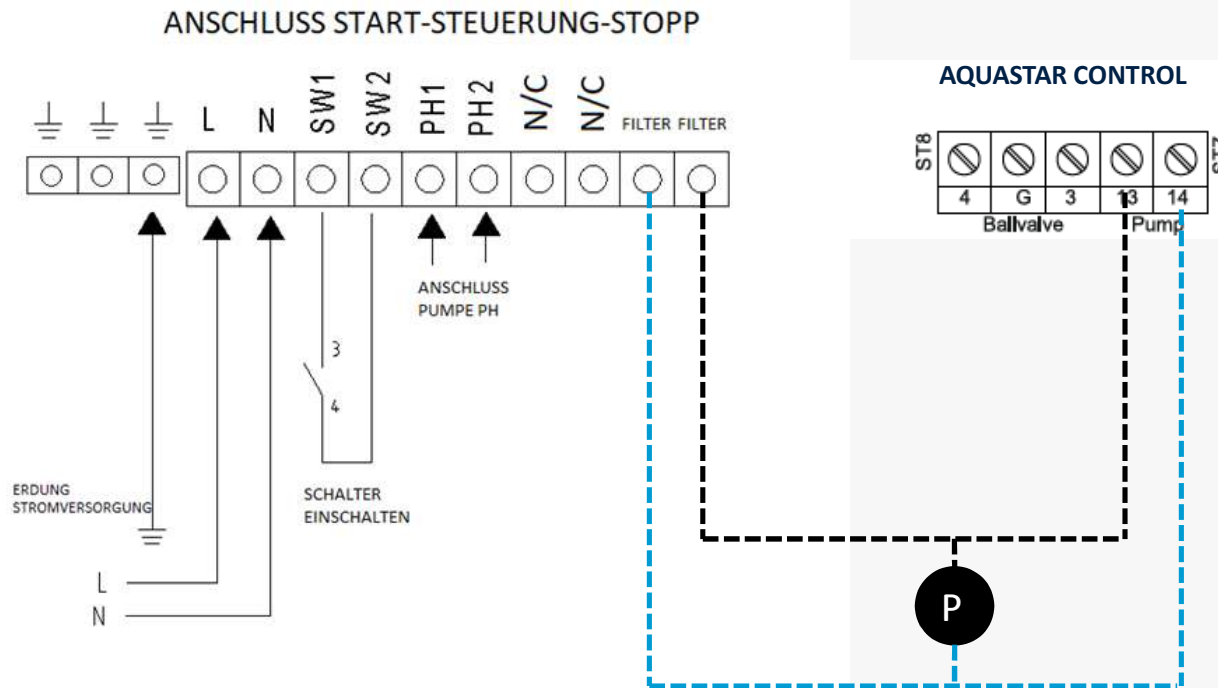

VARIANT 3.1: WITH START-STOP FUNCTION + AQUASTAR CONTROL + 230V PUMP

Same as 2.0, filter control = Aquastar Control