

Versorgung  
230V+N+PE/50-60HZ

-A21  
Aquastar  
LOXONE

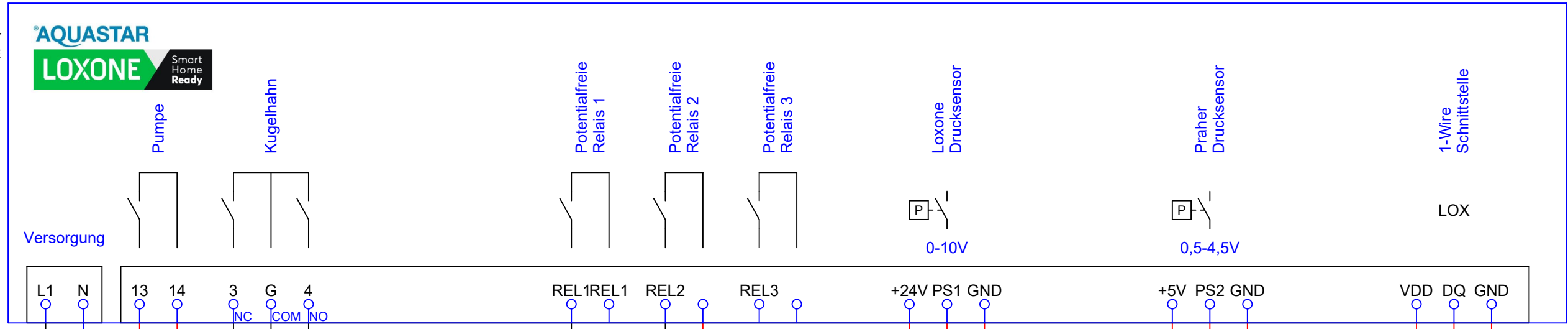

3.2 / AQUASTAR\_13  
3.2 / AQUASTAR\_14

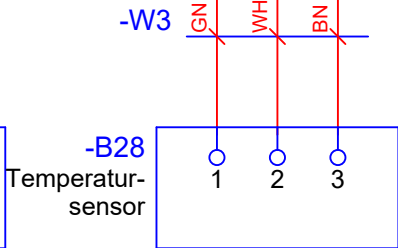
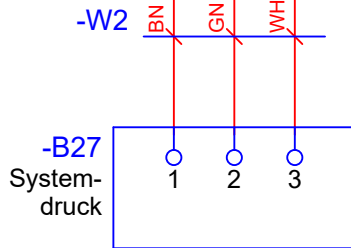
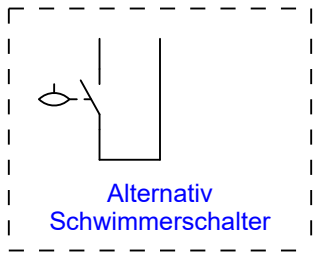
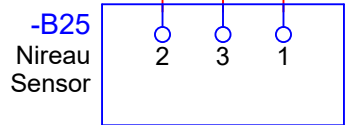
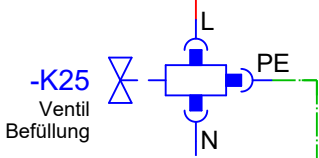
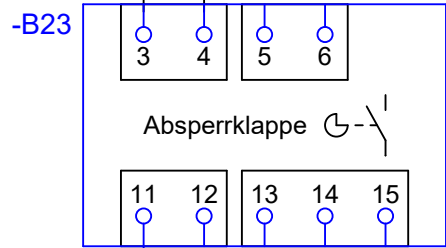

1.9 / L → L / 4.0  
1.9 / N → N / 4.0  
1.9 / PE → PE / 4.0

1.9 / LOX\_0V → LOXONE VER. → LOX\_0V / 3.6

LOXONE VER. → LOX\_24V / 3.6

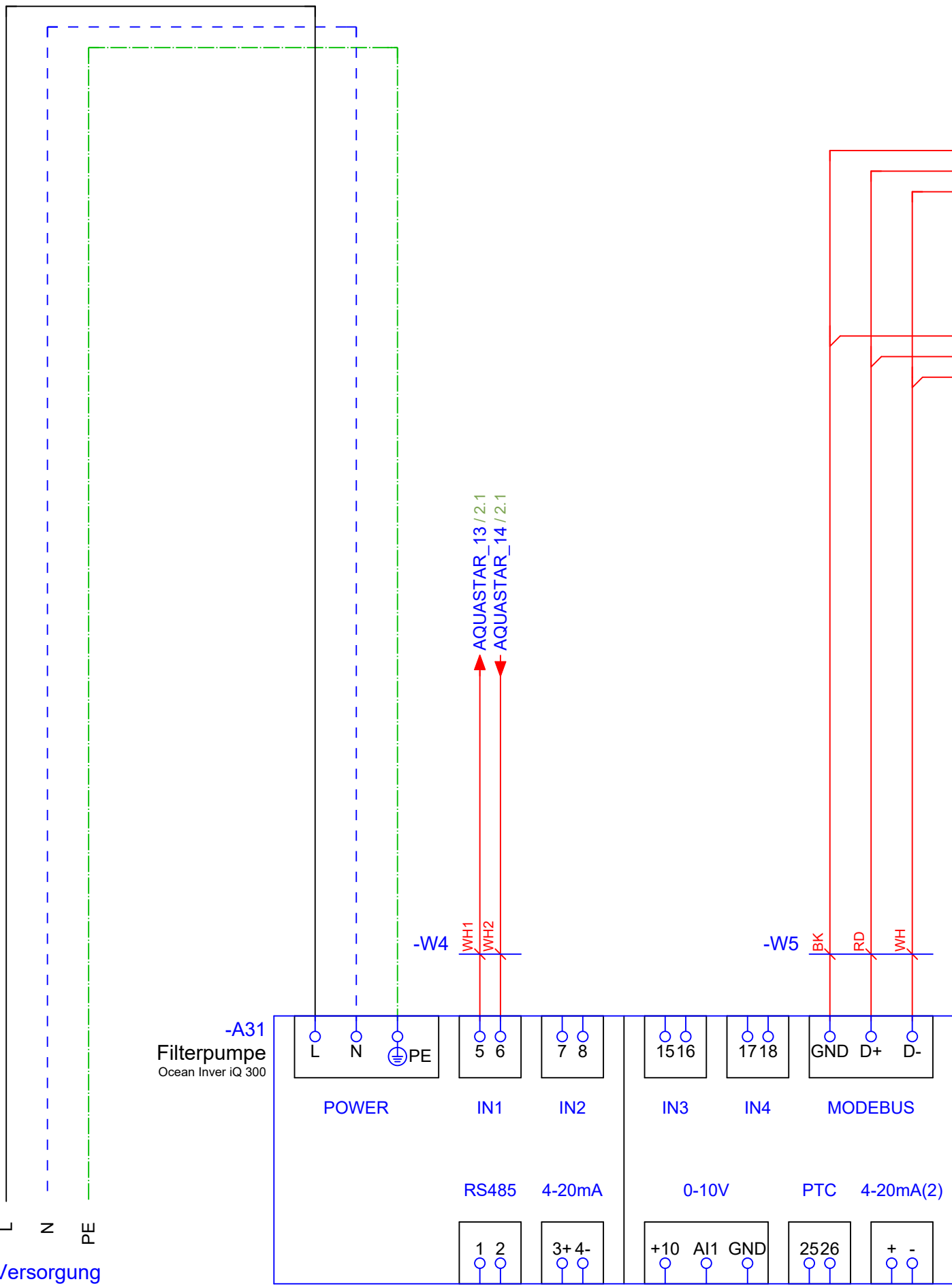

Versorgung  
lt. Typenschild  
230V+N+PE/50-60HZ

Baurate - 9600 Bit/s  
Stoppbits - 1  
Parität - Keine  
Timing - Auto

Modbus GND → MB\_GND / 5.4  
Modbus A → MB\_A / 5.3  
Modbus B → MB\_B / 5.3

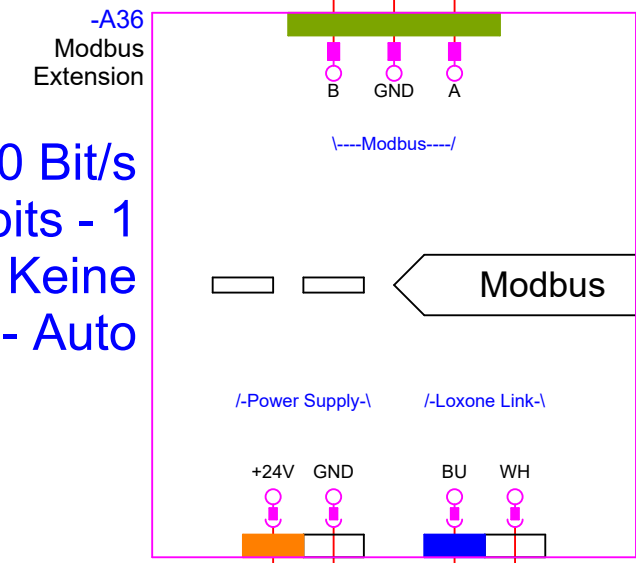

1.9 / LOX\_LINK- → LOXONE BUS (CAN) → LOXONE BUS (CAN) → LOX\_LINK- / 4.6  
1.9 / LOX\_LINK+ → LOXONE BUS (CAN) → LOXONE BUS (CAN) → LOX\_LINK+ / 4.6  
2.9 / LOX\_24V → LOXONE VER. → LOX\_24V / 4.6  
2.9 / LOX\_0V → LOXONE VER. → LOX\_0V / 4.6



Baurate - 57600 Bit/s  
 Anzahl Datenbits - 8  
 Stoppbits - 1  
 Parität - Keine

-A46  
 RS485  
 Extension

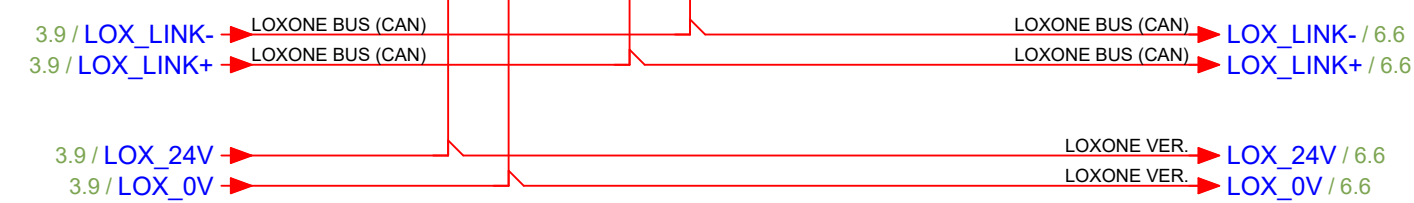
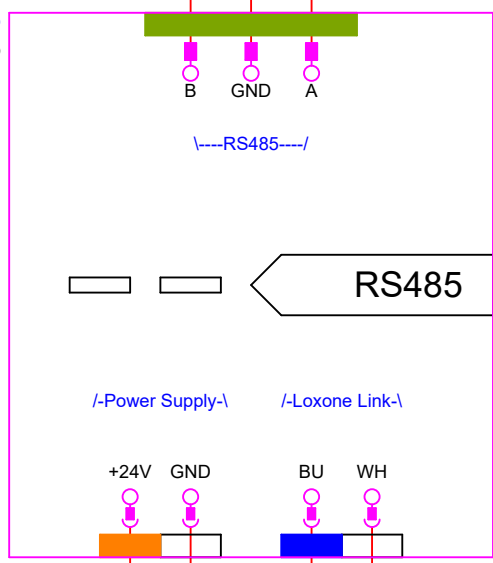

-A41  
 Wasseraufbereitung  
 iQntrol SALT-COMLETE  
 iQntrol DOS-COMLETE  
 iQntrol DOS-NET

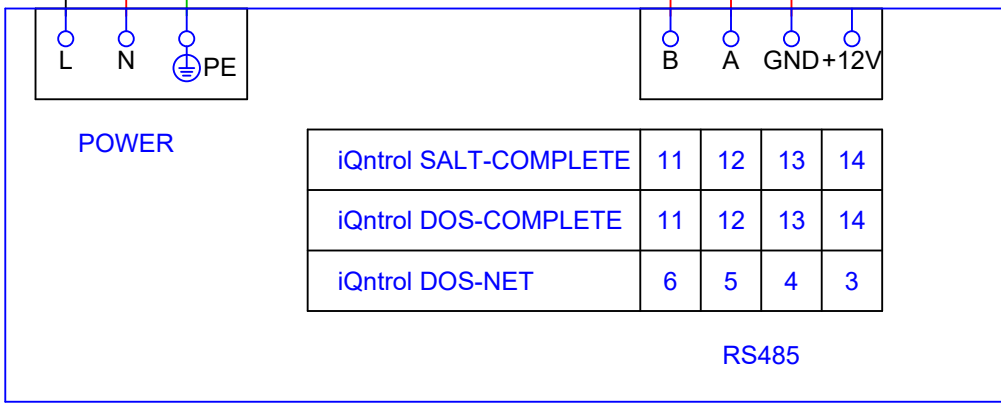

-W6 BK RD WH

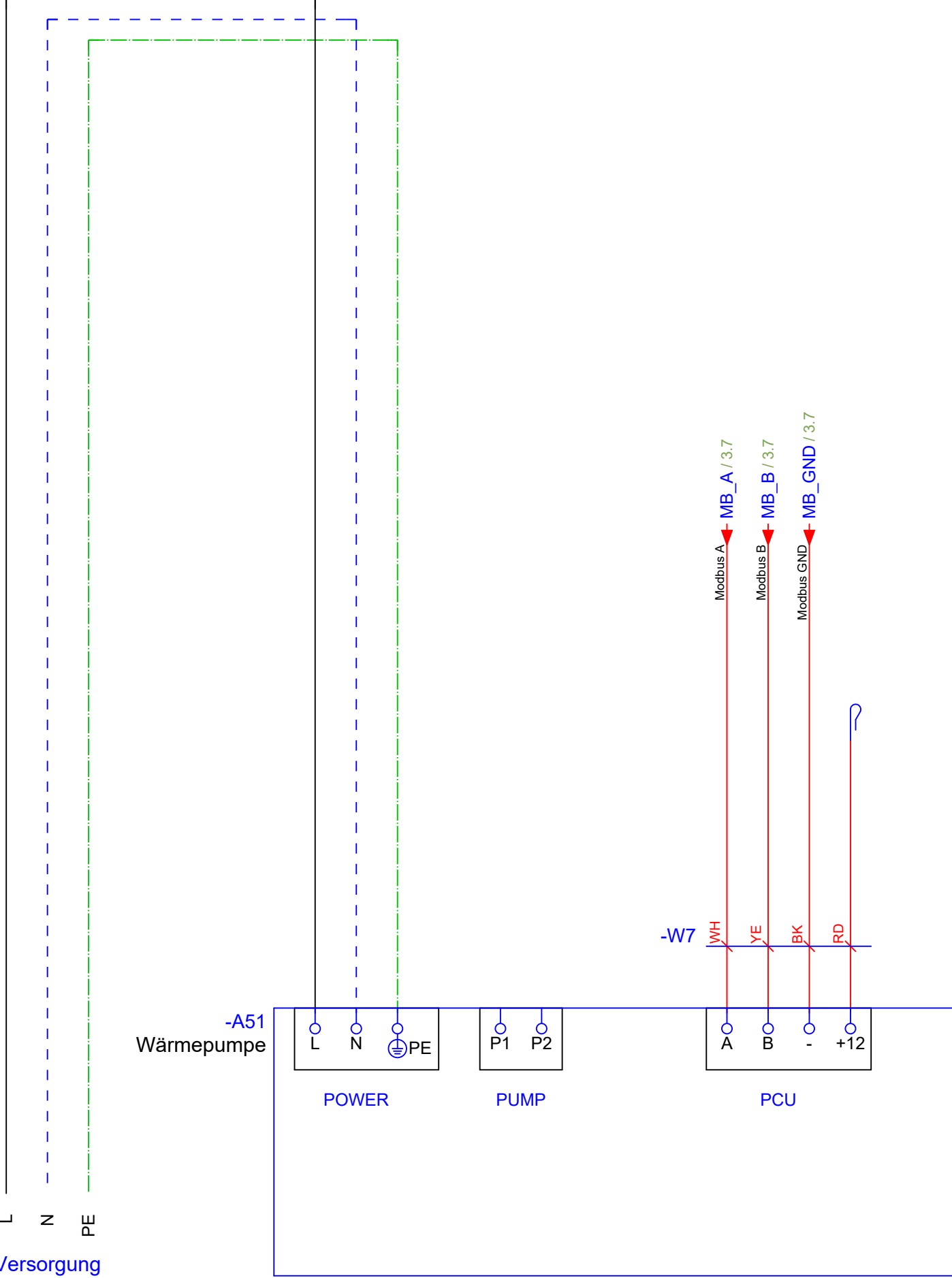

230V+N+PE/50-60HZ

